

PCM 60

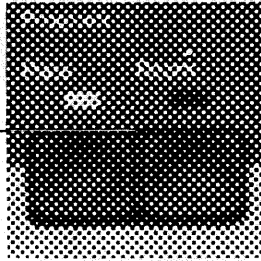

e n g l i s h

o w n e r ' s m a n u a l

Lexicon, Incorporated
60 Turner Street
Waltham, MA 02154 USA
(617) 891-6790
Telex 923 468
© 1984



Export:
Gotham Export Corporation,
New York, NY 10014

lexicon

Unpacking and Inspection

After unpacking the PCM 60, save all packing materials for reshipment. Thoroughly inspect both the unit and the packing materials for indications of shipping damage. Report any damage to the carrier.

Important: A product registration card for the PCM 60 is attached to the back cover of this manual. Please fill out and return this card immediately, so we can supply you with important information on future developments. Retain your bill of sale for proof of warranty.

Precautions

The PCM 60 is a stable device with extensive electronic protection; however, precautions consistent with good practice for any piece of audio gear must be observed as a matter of course.

Always be sure to use the correct ac line voltage; before plugging in your unit, check the rear-panel voltage rating label for the correct operating voltage and read Installation in this manual.

To prevent fire or shock, never operate the PCM 60 in the rain or in exposed wet locations.

Table of Contents

Unpacking and Inspection	2	Applications	10
Precautions	2	Connections	10
Introduction	5	Representative Settings	16
Installation	5	Service	18
Power Requirements	5	Periodic Maintenance	18
Mounting	5	Returning Units for Service	18
Rear-Panel Connectors	6	Ordering Parts	18
Level Adjustment	6	Specifications/Warranty	18
Operation	7	Specifications	18
Front-Panel Controls and Indicators	7	Limited Warranty	20
Reverb Time Charts	8	Log	20
Block Diagram	9		

Notice

Lexicon, Inc., reserves the right to make improvements at any time and without notice in the product described in this manual.

Introduction

The Lexicon PCM 60 Digital Reverberator is a high-performance, low-cost digital reverb designed to be used with a wide range of instruments, stage equipment, and studio mixers. It incorporates the most advanced digital audio processing circuitry available for clean sound and extremely high-quality reverberation.

The PCM 60's controls are easy to use, offering flexible operation and a logical layout. Front-panel LEDs light to indicate selected functions, and a five-segment headroom indicator has been included for precise input level monitoring.

The PCM 60 features two main reverb programs: Room and Plate. From these two programs, you can tailor reverberation characteristics on the basis of size, reverb time, and bass and treble contouring, producing a wide variety of distinct reverberation effects. Rotary knobs are used to set input gain, reverb mix, and output level. A Bypass mode switch with optional foot pedal control is included; the unit is automatically placed in Bypass mode when switched off.

For compatibility with the widest range of peripheral audio equipment, the PCM 60 has a balanced/unbalanced audio input (mono in), two unbalanced (single-ended) audio outputs (stereo out), and an effects loop — all using standard ¼-in. phone jacks. Input and output sensitivity select push-buttons on the rear panel can be set for high- or low-level inputs and high- or low-level outputs.

This product is the result of years of study and development. Its design incorporates suggestions from knowledgeable users and reflects Lexicon's long experience in providing superior digital audio equipment to the professional. Every effort has gone into making the PCM 60 perform to the highest industry standards. We welcome comments on its use and functionality and hope that it provides many years of satisfaction and enjoyment.

Installation

Power Requirements

The factory preset nominal operating voltage appears on the rear panel; maximum power consumption is 20 W. The non-detachable power cord uses a standard 3-pin IEC connector, providing chassis grounding to the ac main line.



The PCM 60 can be operated at either 100/120 Vac or 220/240 Vac, depending on the setting of an internal voltage changeover switch and its main fuse rating. The following table lists the nominal operating voltages, switch settings, and appropriate fuse ratings.

Mounting

The PCM can rest on any flat surface, or it can be mounted in a standard 19-in. (483 mm) relay rack; it is 1¾ in. (44 mm) high by 11 in. (280 mm) deep. Do not install the PCM 60 above heat-producing equipment. Its maximum ambient operating temperature is 35°C (95°F).

To protect from mechanical shock during transport, support the rear chassis of rack-mounted units.

Operating Voltages

Nominal Voltage (V)	Switch Setting*	Fuse Rating
100/120		0.5 A, 3AG slow blow
220/240		0.25 A, 3AG slow blow

WARNING: This procedure must be performed by a qualified service technician.

*Labeled SW11 on motherboard silk screen; arrow indicates direction to set switch using a small flat-blade screwdriver, with front panel facing you.

Rear-panel Connectors

1 Bypass Switch

This jack is for remote operation of the bypass function. The unit can be placed in Bypass mode using either an optional remote footswitch or the front-panel switch; however, plugging in a footswitch disables the front-panel switch. When using a footswitch, the front-panel LED lights when the unit is in Bypass mode. The Bypass jack accepts a ¼-in. tip/sleeve phone plug for connection to a momentary or on/off footswitch (use optional Lexicon footswitch: 750-02834).

2 Effects Return

This jack is for an effects signal from a delay line, compressor, fader, or a variety of similar effects equipment; the signal is applied to the input of the PCM 60's reverb processor. It accepts a ¼-in. tip/sleeve phone plug and signals up to 1 V (0 dBV).

3 Effects Send

This jack is for sending a signal to a delay line or other effects device. It accepts a ¼-in. tip/sleeve phone plug and sends an unbalanced, 1-V signal.

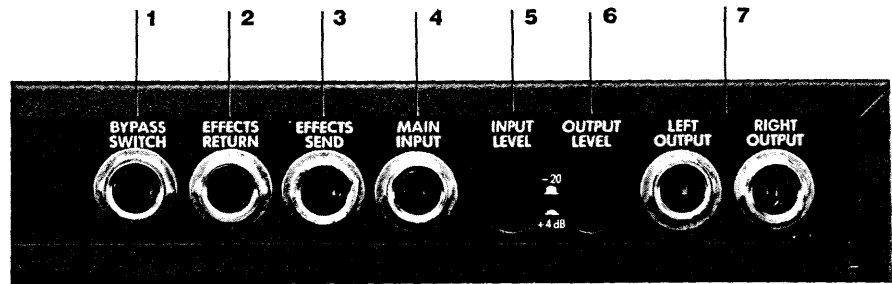

4 Main Input

This jack is for the main audio input; levels and impedance are determined by Input Level Selector. In the +4 dB sensitivity mode, the input can be used for balanced, studio-level signals; in the -20 dB sensitivity mode, the input can be used for unbalanced, high-impedance instruments or other low-output equipment. It accepts a ¼-in. tip/ring/sleeve phone plug.

5 Input Level Selector

This pushbutton selects levels and impedance for the Main Input:
+4 dB: -8 to +18 dBV balanced, 40 kilohms parallel with 150 pF
-20 dB: -23 to +3 dBV unbalanced, >500 kilohms parallel with 150 pF

6 Output Level Selector

This pushbutton selects levels for Left and Right Outputs:
+4 dB: +10 dBV maximum into 600 ohms; +16 dBV maximum into 10 kilohms or greater
-20 dB: -8 dBV maximum into 10 kilohms or greater

7 Left and Right Outputs

These jacks are for the main audio outputs; levels are determined by the Output Level Selector and Output Level Control. Each accepts a ¼-in. tip/sleeve phone plug. Output impedance is 600 ohms, regardless of level setting. In Bypass mode, both outputs are connected directly to the main input jack.

Level Adjustment

For optimum performance, put the PCM 60 in Bypass mode and adjust the input level so that the loudest passages cause the 0-dB LED to flash only occasionally. Then set the Output Mix control to Dry and adjust the Output Level control until the operating level is the same with the Bypass button in or out.

Important: The PCM 60's headroom indicator is an instantaneous peak-reading meter and shows the true maximum level of the input signal. Therefore, optimum operation occurs when input levels light the amber LED in the headroom indicator.

WARNING: Do not overdrive the PCM 60—its clipping characteristics, like those of other digital equipment, are very abrupt.

Operation

Front-panel Controls and Indicators

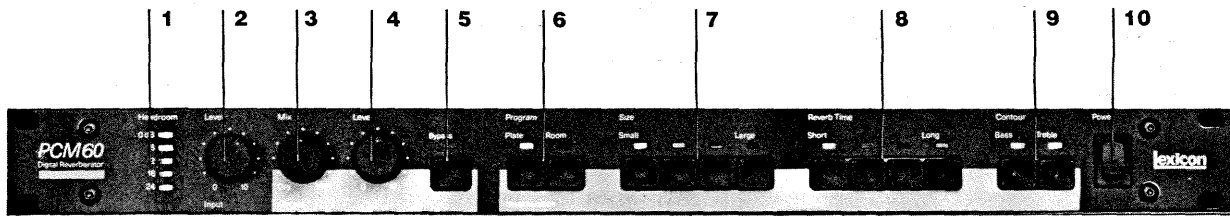

1 Headroom Indicator

This 5-segment LED display shows peak/hold and overload for the input signal. For optimum performance, adjust the input level so that all LEDs up to the red one flash. A flashing red LED indicates clipping.

2 Input Level Control

This rotary knob controls the level of the input signal. If the red LED in the headroom indicator flashes frequently, lower the input level.

3 Output Mix Control

This rotary knob controls the mixing balance between the direct signal (Dry) and the reverberant signal (Wet).

4 Output Level Control

This rotary knob controls the output level from the PCM 60; it does not affect the level of signals when the unit is in Bypass mode.

5 Bypass

When activated, this pushbutton places the PCM 60 in direct-relay Bypass mode: all processing functions are bypassed, and the main input is directly connected to both outputs. Controllable with an optional foot pedal. For optimum performance, adjust the PCM 60 for unity gain with the Bypass button out and the Output Mix control set to Dry.

6 Program Select Function

The Room pushbutton selects the Room reverberation program; the Plate pushbutton selects the Plate program.

7 Size Select Function

These pushbuttons select the apparent size of the acoustical space created by the PCM 60's programs. As in naturally occurring reverberation, increasing the size also increases the reverberation time.

8 Reverb Time Select Function

These pushbuttons select four reverb times from 0.2 to 3.8 seconds for the Room program and from 0.3 to 3.8 seconds for the Plate program. Actual reverb time changes with the size control.

9 Reverb Contour Select (Program Dependent)

These pushbuttons alter frequency response for both programs. Specific contouring is program dependent (see Specifications). The perceived effect for both programs is that pushing in the Bass button produces longer low-frequency reverb times and pushing in the Treble button produces shorter high-frequency reverb times.

10 Power Switch

This switch turns the power on or off; the unit powers up with the setting indicated by lit LEDs.

Reverb Time Charts

Room Program

Size	Reverb Time (in seconds)				
	Large	Short	Long		
	37 ms	0.8	1.6	2.7	3.8
	16 ms	0.7	1.5	2.4	3.4
	9 ms	0.6	1.1	1.9	2.6
6 ms*		0.3	0.7	1.1	1.6

Plate Program

Size	Reverb Time (in seconds)				
	Large	Short	Long		
	46 ms	0.7	1.5	2.9	4.5
	7 ms	0.6	1.4	2.6	4.0
	2 ms	0.4	0.9	1.7	2.7
1 ms		0.2	0.6	1.1	1.6

*milliseconds of predelay

Block Diagram

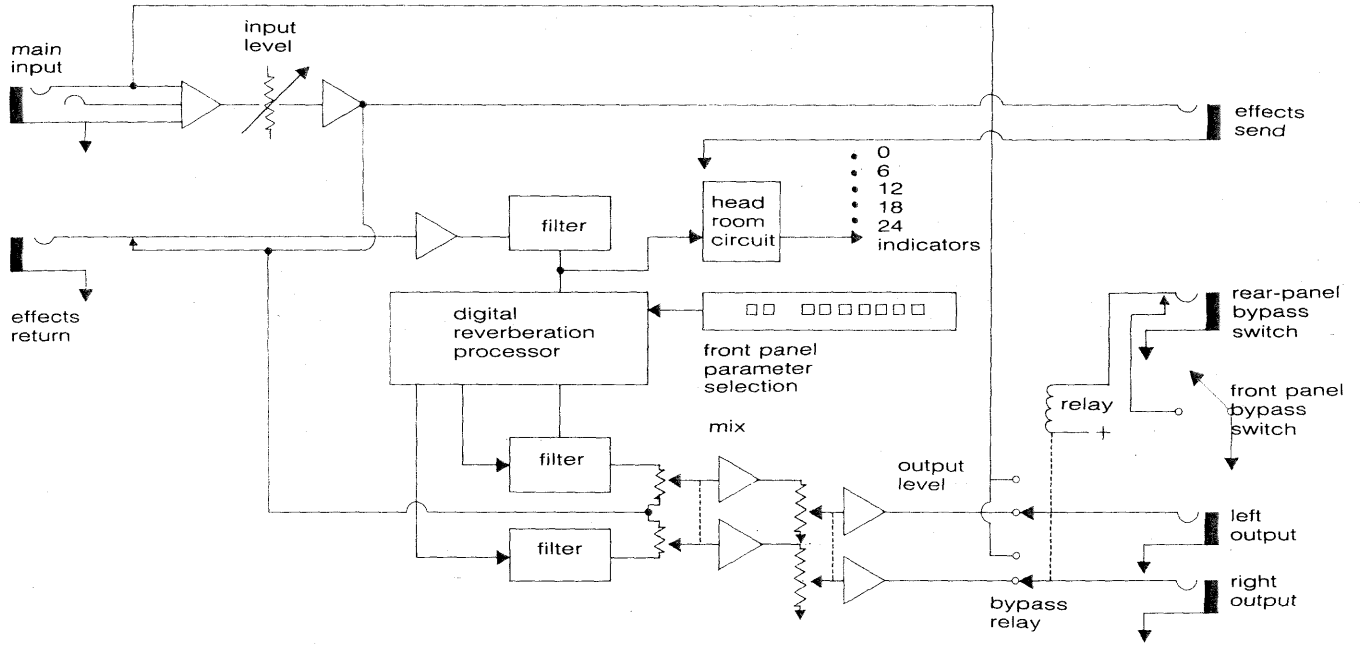

Applications

Many of the applications for the PCM 60 require connections to a variety of professional audio equipment; the connections described in this section serve as general introductions to possible performance, sound reinforcement, or studio applications. Actual connections must be carefully checked for proper impedance, balance, and levels. Reverberation and other sonic shadings are highly subjective, and what satisfies one person may not appeal to another. We hope that you use the representative setups contained here as starting points for your own sound.

Connections

Figure 1 shows the basic in-line connection for the PCM 60 to be used with amplifiers. If a mono output is desired, insert only one output plug into either left or right output. Figures 2 and 3 show the PCM 60 connected to single and dual guitar amplifiers.



Fig. 1. Basic in-line connection.

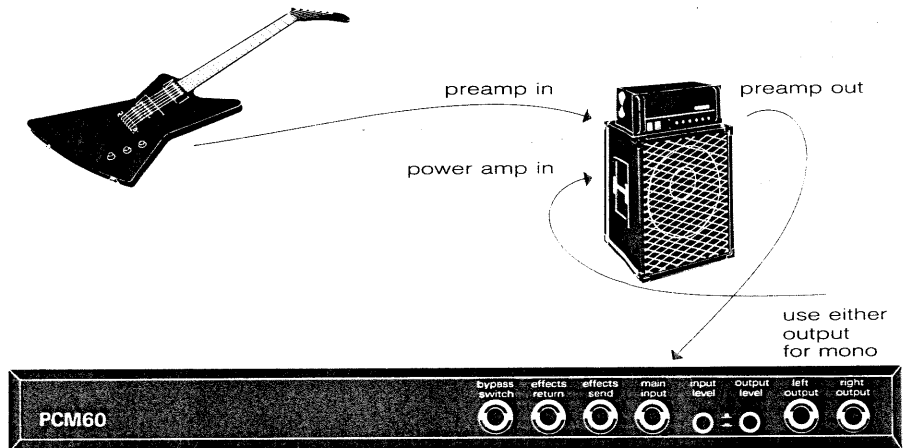

Fig. 2. Connection to single guitar amplifier.

If gross distortion occurs when using the PCM 60 with a guitar amplifier, the problem could be with the amplifier. Some popular units cause distortion if the Preamp Output is not disconnected from the Power Amp Input when a plug is inserted. If this problem exists, contact the amplifier manufacturer or an authorized service center.

Figure 4 shows the PCM 60 connected to a mixing console.

For optimum performance in the Bypass mode, adjust the PCM 60's input level so that the loudest passages cause the 0-db LED to flash only occasionally. Set the Output Mix control to Dry and adjust the Output Level control until the pcm 60's operating level is the same with the Bypass button in or out.

Delay Lines. Pre-delay is often used to increase the sense of space and to separate direct and reverberant sound. Pre-delay puts the direct sound more "in front" of the reverberant signal. A delay of 20 to 200 milliseconds is useful for this purpose.

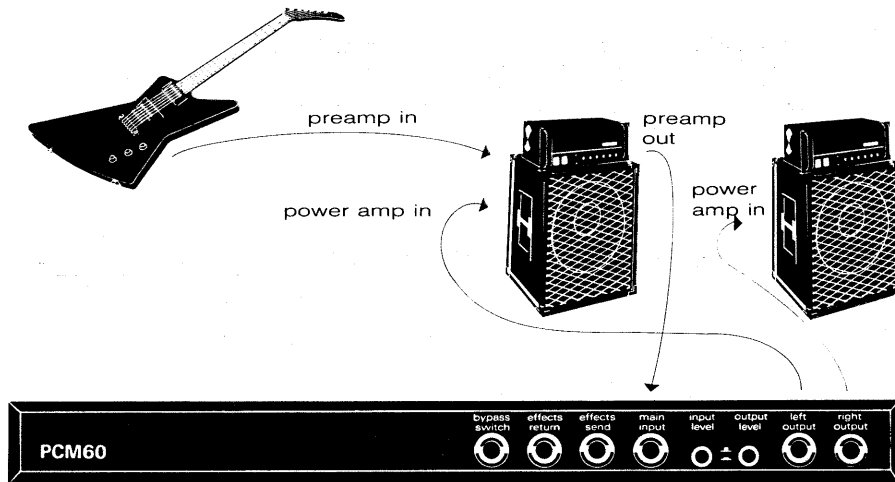

Fig. 3. Connection to dual guitar amplifiers.

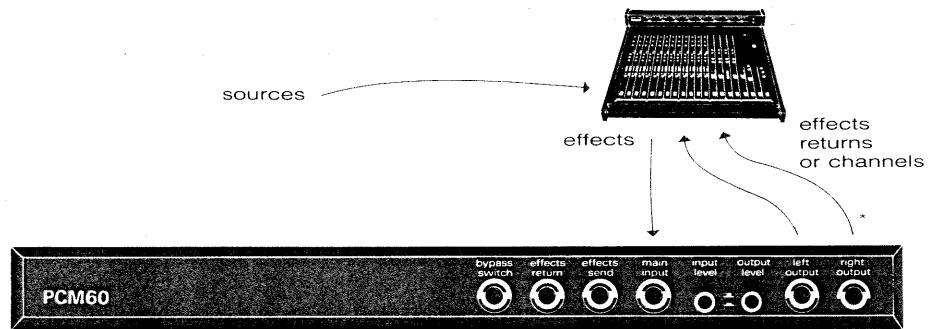

Fig. 4. Connection to mixing console.

*for a mono return, use either output

Although the PCM 60's room and plate programs already have small amounts of pre-delay (see page 8), additional pre-delay can be added by inserting a delay line into the PCM 60's effects loop. Set up the delay line for unity gain, and adjust it so that the output contains only delayed signal, with no regeneration (feedback) or sweep.

The delay unit can also be used for special effects such as chorusing, flanging, or discrete repeats, which are then reverberated.

Figure 5 shows a delay line connection.

Equalizers. An external graphic or parametric equalizer can be used to affect the reverberant signal by changing the frequency content of the source. The equalizer can be used to obtain an extra "edge" at the high end of reverberation, or to emphasize the low- or mid-range portion of the response. Figure 6 shows an audio equalizer connection.

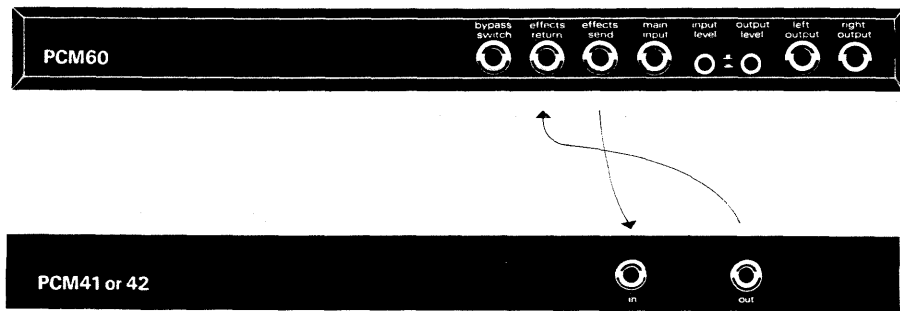

Fig. 5. Use of a digital delay line (Lexicon PCM 41 or 42) for increasing pre-delay.

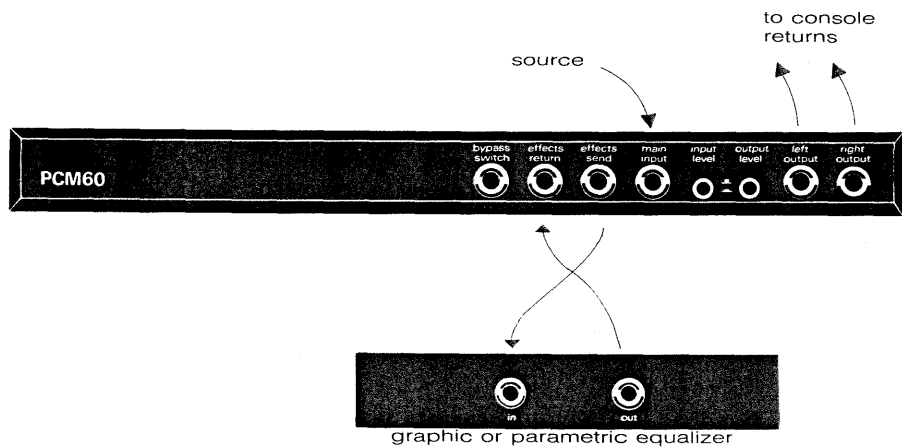

Fig. 6. Connection to audio equalizer.

Dynamic Processors. Various types of dynamic processors can be used with the PCM 60, either placed in the send/return effects loop, or applied to the reverb output. The effect of dynamic processing on the sound is very different for these two patches.

Processing the signal from the send/return loop will regulate the signal reaching the reverb chamber. For example, reverb can be applied only to the peaks of a vocal or instrumental line by using an expander. Or, an externally keyed gate may be used to apply reverb selectively. Figure 7 shows the PCM 60 connected to a dynamic processor in the send/return loop.

Processing the reverb output affects the actual decay times. Dynamic processing can be used to stretch time, using compression, or to provide sharp cutoff after dense reverb, using gating or expansion. Figure 8 shows dynamic processing applied to the reverb output.

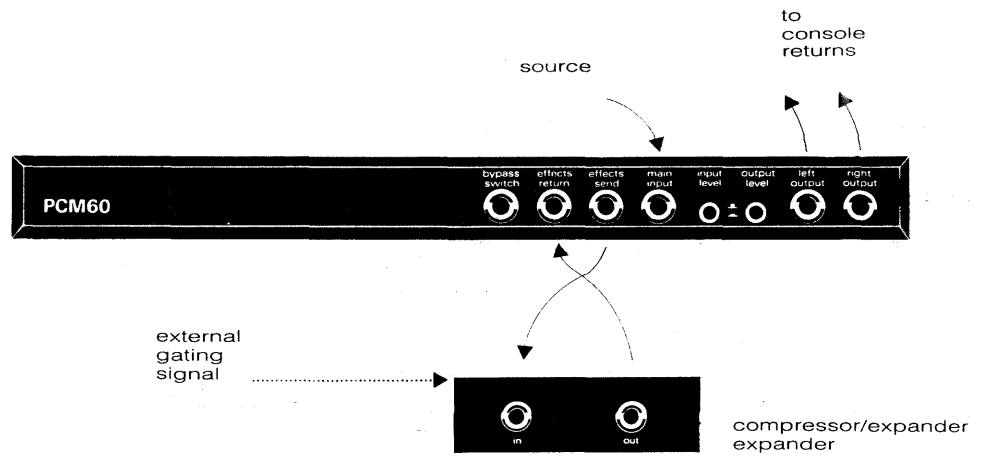

Fig. 7. Connection of dynamic processor in send/return loop.

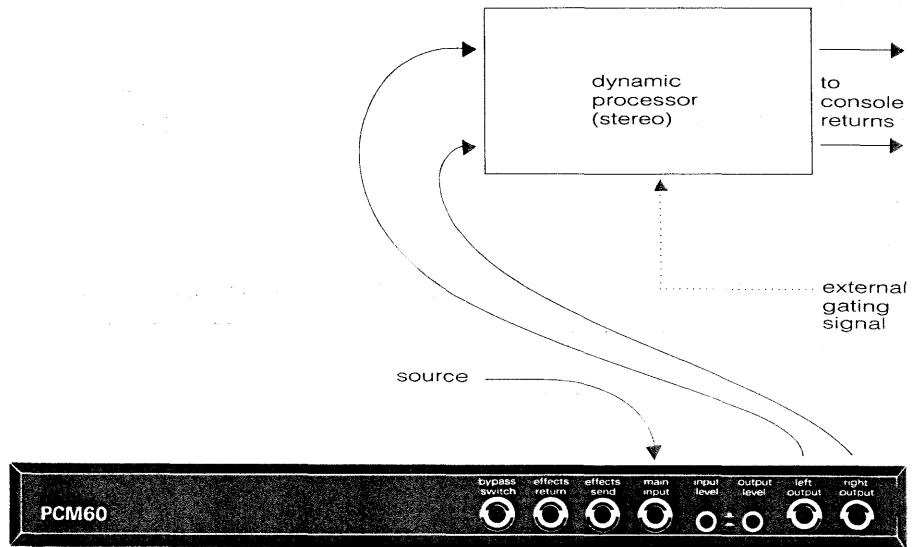

Fig. 8. Connection of dynamic processor to reverberation output.

Multiple Units. More than one PCM 60 can be used at the same time. This feature of the PCM 60 encourages creative setups.

Two PCM 60s can be used with *different* settings, with both reverbs separately combined at the mixing console. The sounds produced by this setup are very different from the sounds produced by one unit. Figure 9 shows two PCM 60s connected.

Further combinations of reverb envelopes can be obtained by using a Lexicon Model 95 with two PCM 60s for dual pre-delay, as shown in Fig. 10.

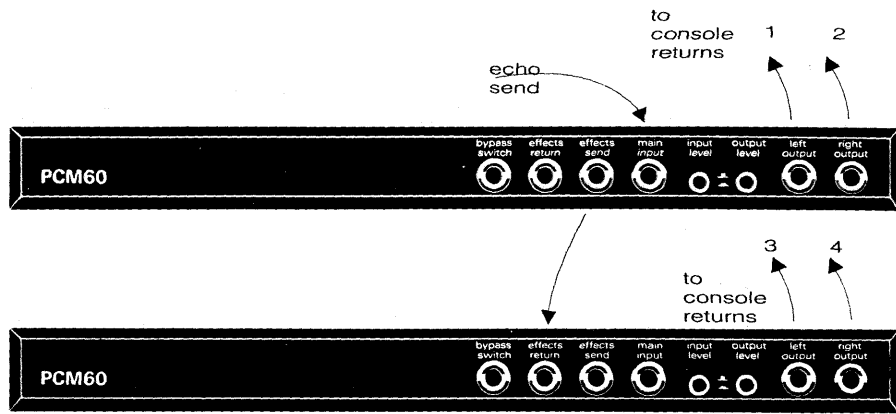

Fig. 9. Connecting two PCM 60s.

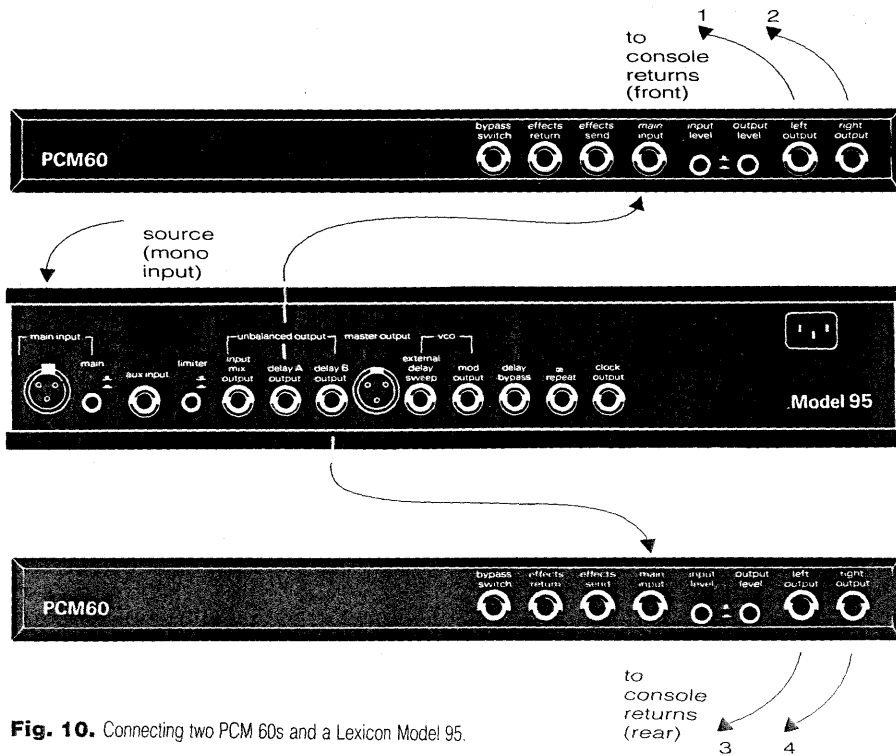

Fig. 10. Connecting two PCM 60s and a Lexicon Model 95.

Two PCM 60s can be combined in series. However, an undesirable amount of signal coloration may occur for some settings. Figure 11 shows two PCM 60s connected in series.

Multiple units can also be hooked to separate echo sends to create different "layers" of reverb. This can be very effective for contemporary production. Figure 12 shows the use of a PCM 60 at short reverb times to produce a stereo imaging effect on a monaural signal.

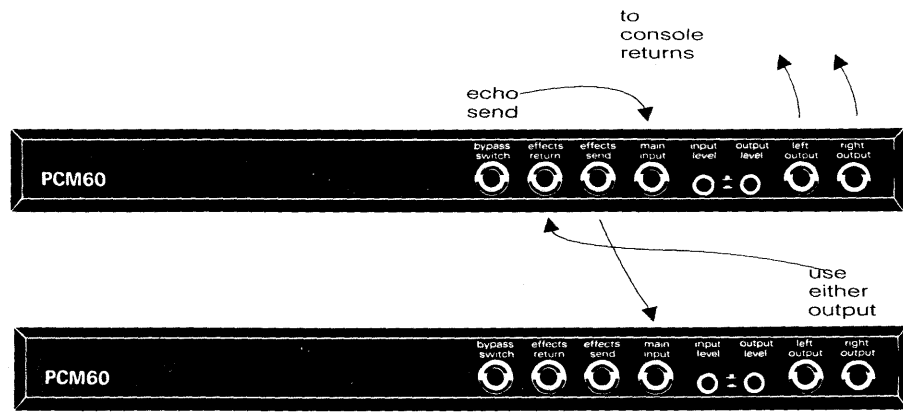

Fig. 11. Two PCM 60s connected in series.

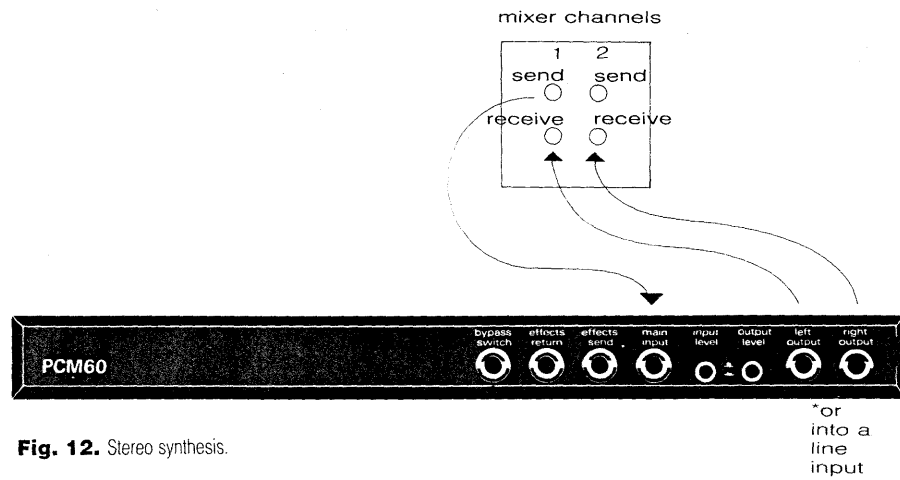

Fig. 12. Stereo synthesis.

Representative Settings

This section contains sample settings for the PCM 60. Actual settings used in production are so much a function of musical context and purpose that specific sounds for a particular instrument cannot be indicated here; however, the suggestions given in this section can be used as starting points. Note that suggested settings are given for the Mix control; if you are using the PCM 60 with a separate mixer, set the control to Wet.

Vocals. The vocal reverb setting shown in Fig. 13 provides a long, rich decay for ballads or other expressive vocal forms. This setting is also useful for strings. Predelay may be a useful addition to this setting.

The vocal enhancement setup, shown in Fig. 14, provides a warm sense of space without a large amount of reverb "tail." This setup is also useful for instrumental lines.

Percussion. For percussive sounds, the Plate program generally provides the densest reverberation (the Room program provides a more "open" sound). Very short reverberation times are especially useful when recording electronic drums, producing a realistic drum sound. Figures 15 and 16 show drum setups.

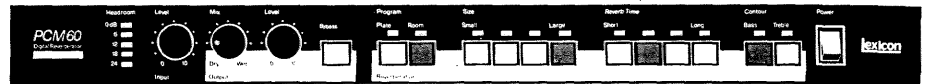

Fig. 13. Vocal reverb.

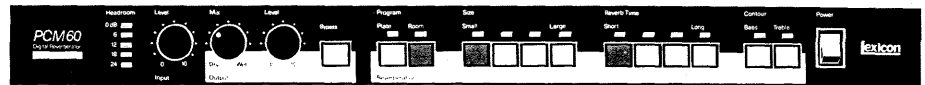

Fig. 14. Vocal enhancement.



Fig. 15. Contemporary snare sound.



Fig. 16. Kick drum sound of the 50s and 60s.

Figure 17 shows a setting very useful for adding ambience to all types of electronic instruments.

Guitar. The PCM 60 can be used for long reverberation of guitar leads, and at shorter reverb times, it enhances rhythm guitar parts. Figures 18 and 19 illustrate these setups.

Piano. For acoustic piano, the PCM 60 provides a realistic simulation of a high-quality concert hall; see Fig. 20. Of course, many other settings can be used on either electric or acoustic instruments.



Fig. 17. Room sound for drum units.

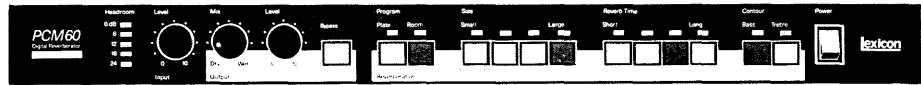

Fig. 18. Lead guitar sound.

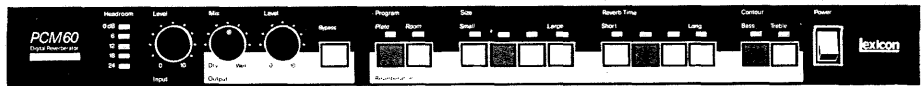

Fig. 19. Rhythm guitar sound.

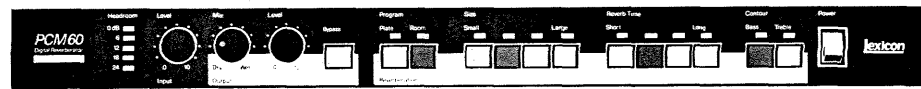

Fig. 20. Concert piano sound.

Service

Periodic Maintenance

Under normal conditions, the PCM 60 requires no maintenance. To clean the front panel use a soft lint-free cloth lightly dampened with a mild detergent solution. Do not use alcohol-, benzene-, or acetone-based cleaners or strong commercial cleaners; never use abrasive material such as steel wool or metal polish.

Returning Units for Service

If the PCM 60 must be returned to Lexicon or a designated facility for service, Lexicon assumes no responsibility for the unit in shipment from customer to factory, whether in or out of warranty. All shipments must be well packed (using the original packing materials, if possible), properly insured, and consigned to a reliable agent, such as UPS or Federal Express. If original packing materials are not available, please procure a new packing kit from Lexicon.

Always consult with Lexicon before returning a unit, to determine the extent of a problem and to decide on a shipping procedure.

When returning a unit for service, include the following information:

Name (and Company Name)
Address
City, State, ZIP
Telephone Number
Serial Number of Unit
Description of Problem
Desired Return Date
Preferred Method of Return Shipment

Please include a note describing conversations with Lexicon personnel, and give the name and telephone number of the person directly responsible for maintaining the equipment. Do not include accessories, such as manuals or remote switches.

Note: For units outside of the USA and Canada, contact Gotham Export Corporation, 741 Washington Street, New York, NY 10014, (212) 741-7411, Telex 129 269.

Ordering Parts

Replacement parts can be ordered from:

Lexicon, Inc.
60 Turner Street
Waltham, MA 02154 USA
(617) 891-6790
Telex 923 468
Attn: Customer Service

Specifications

Frequency Response

Reverberant Signal: 20 Hz to 10 kHz, ± 1 dB.

Direct Signal: 20 Hz to 20 kHz, ± 0.25 dB.

Dynamic Range

Reverberant Signal: 80 dB, 20-Hz to 20-kHz noise bandwidth.

Total Harmonic Distortion (THD) and Noise

Reverberant Signal:
 $\leq 0.05\%$ @ 1 kHz and full level.

Direct Signal: $\leq 0.025\%$ @ 1 kHz @ 3 V out.

Reverberation Time

Room Program: 0.3 to 3.8 seconds.

Plate Program: 0.2 to 4.5 seconds.

Frequency Contouring

Program dependent:

Room program
Bass out and Treble out:
flat frequency response.

Bass in and Treble out:
low-frequency reverb time is increased by approximately 50% below 800 Hz.

Bass out and Treble in:
high-frequency reverb time is decreased by approximately 25% above 800 Hz and a gentle rolloff above 2 kHz is added to simulate room absorption.

Bass in and Treble in:
low-frequency reverb time is increased by approximately 50% below 800 Hz and high-frequency reverb time is decreased by approximately 25% above 800 Hz and a gentle rolloff above 2 kHz is added to simulate room absorption.

Plate program
Bass out and Treble out:
low-frequency reverb time is decreased by approximately 50% below 800 Hz.

Bass in and Treble out:
low-frequency reverb time is increased by approximately 50% below 800 Hz.

Bass out and Treble in:
flat frequency response.

Bass in and Treble in:
high-frequency reverb time is decreased by approximately 25% above 800 Hz and a gentle rolloff above 2 kHz is added to simulate room absorption.

Displays

LED indicators for Bypass, Program, Size, Reverb Time, and Contour; and 5-segment LED headroom indicator with 24-dB range.

Audio Input

Levels
+4 dB: -8 to +18 dBV balanced; -20 dB: -23 to +3 dBV unbalanced.

Impedance
+4 dB: 40 kilohms parallel with 150 pF balanced; -20 dB: >500 kilohms parallel with 150 pF unbalanced.

Connector
1/4-in. tip/ring/sleeve phone jack.

Audio Output

Levels
+4 dB: +10 dBV into 600 ohms; +16 dBV into 10 kilohms or greater.

-20 dB: -8 dBV into 10 kilohms or greater.

Impedance
600 ohm; unbalanced.

Connector
1/4-in. tip/sleeve phone jack.

Effects Send

Level
0 dBV at machine operating level.

Impedance
600 ohms unbalanced.

Connector
1/4-in. tip/sleeve phone jack.

Effects Return

Level
0 dBV for full machine level.

Impedance
>50 kilohms parallel with 150 pF unbalanced.

Connector
1/4-in. tip/sleeve phone jack.

Bypass Remote

1/4-in. tip/sleeve phone plug for connection to momentary footswitch; for use with optional Lexicon footswitch: 750-02834.

Power

Nominal: 100, 120, 220, 240 Vac (-10%, +5%) switch-selectable; 50 to 60 Hz; 20 W.

RFI Shielding

Meets all requirements for FCC Class A computer equipment.

Protection

Mains fused; voltage crowbar and/or current limiting for internal supplies.

Environment

Operating: 0 to 35°C (32 to 95°F); storage: -30 to 75°C (-22 to 167°F); relative humidity: 95% maximum (without condensation).

Dimensions

Standard 19-in. rack mount: 19" w x 1 3/4" h x 11" d (483 x 44 x 280 mm).

Weight

9.2 lb (4.2 kg); shipping: 11 lb (5 kg).

Log

Limited Warranty

Lexicon warrants each Model 60 Digital Reverberator to be free from defects in material and workmanship under normal use and service for one year. This warranty begins on the date of delivery to the purchaser or his authorized agent or carrier. During the warranty period, Lexicon will repair, or at its option replace, at no charge components that prove to be defective provided that the equipment is returned, shipping prepaid, to Lexicon's factory or designated service facility.

The warranty is null and void under the following conditions:

- 1** Abuse, neglect, alteration, or repair by unauthorized personnel.
- 2** Damage caused by improper use or operation from an incorrect power source.
- 3** Damage caused by accident, act of God, war, or civil insurrection.

Lexicon is not responsible for loss or damage, direct or consequential, resulting from machine failure or the inability of the product to perform. Lexicon shall not be responsible for damage or loss during shipment to or from its factory or designated service facility.

Lexicon reserves the right to make changes or improvements in the design or construction of the machine without obligation to make such changes or improvements in the purchaser's machine.

No equipment may be returned under this warranty without prior authorization from Lexicon. Shipments must be packed in authorized Lexicon packing material, fully insured, and prepaid.

This warranty is in lieu of all other warranties, expressed or implied, and of any other liabilities on Lexicon's part; in addition, Lexicon does not assume or authorize anyone to make any warranty or assume any liability not strictly in accordance with the above.

Use photocopies or reprints of this page to log or annotate your settings. Mark appropriate levels on knobs and shade in keys to represent selections.

I.D.

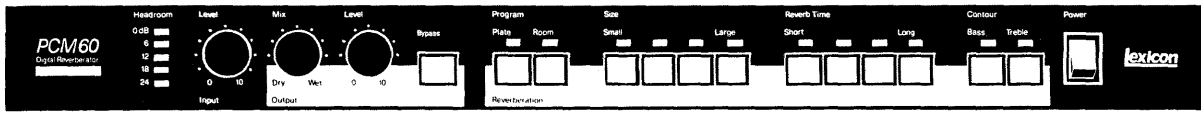

Notes

I.D.

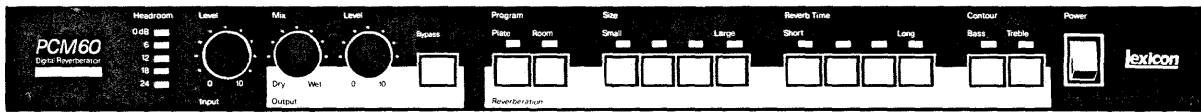

Notes