

MPX 1
Multi Processor FX User Guide

lexicon

Dansk

Vigtig information om sikkerhed

Gem denne vejledning til senere brug.

Følg alle anvisninger og advarsler på apparatet.

Apparatet skal altid tilsluttes den korrekte spænding. Der henvises til brugsanvisningen, der indeholder specifikationer for strømforsyning. Der gøres opmærksom på, at ved varierende driftsspændinger kan det blive nødvendigt at bruge andre lednings- og/eller stiktyper.

Apparatet må ikke monteres i et kabinet uden ventilation eller lige over andet udstyr, der udvikler varme, f.eks. forstærkere. Den maksimale omgivelsestemperatur ved drift, der står opført i specifikationerne, skal overholdes.

Der er ventilationsåbninger i kabinettet. For at sikre apparatets drift og hindre overophedning må disse åbninger ikke blokeres eller tildækkes. Stik aldrig noget ind igennem ventilationsåbningerne, og pas på aldrig at spilde nogen form for væske på apparatet.

Dette apparat er forsynet med et stik med jordforbindelse. Denne sikkerhedsforanstaltning må aldrig omgås.

Udgangsstik fra audioforstærkere må aldrig sættes direkte i apparatet.

Apparatet må ikke udsættes for regn eller fugt og må ikke bruges i nærheden af vand for at undgå risiko for elektrisk stød og brand.

Apparatet må aldrig bruges, hvis det er blevet stødt, beskadiget eller vådt, eller hvis ændringer i ydelsen tyder på, at det trænger til eftersyn.

Dette apparat må kun åbnes af fagfolk. Hvis dækslet tages af, udsættes man for livsfarlig højspænding.



Denne mærkat på komponenten advarer om uisoleret, farlig spænding i apparatet ... høj nok til at give elektrisk stød.



Denne mærkat på komponenten advarer om vigtig drifts- og vedligeholdelsesinformation i den tilhørende litteratur.

Suomi

Tärkeitä turvallisuusohjeita

Säilytä nämä ohjeet tulevaa käyttöä varten.

Seuraa kaikkia yksikköön merkittyjä ohjeita ja varoituksia.

Käytä aina oikeaa verkkojännitettä. Tehovaatimukset selviävät valmistajan käyttöohjeista. Huomaa, että eri käyttöjännitteet saattavat vaatia toisenlaisen verkkojohdon ja/tai -pistokkeen käytön.

Älä asenna yksikköä telineeseen jossa ei ole tuuletusta, tai väliittävästi lämpöä tuottavien laitteiden, esim. tehovahvistimien, yläpuolelle. Ympäristön lämpötila käytössä ei saa ylittää tuotespesifikaation maksimilämpötilaa.

Kotelo on varustettu tuuletusreiillä ja -aukoilla. Luotettavan toiminnan varmistamiseksi ja yllämpenemisen välttämiseksi näitä aukkoja ei saa sulkea tai peittää. Mitään esineitä ei saa työntää tuuletusaukkoihin. Mitään nesteitä ei saa kaataa yksikköön.

Tuote on varustettu 3-johimisella maadoitetulla verkkopistokkeella. Tämä on turvallisuustoiminne eikä sitä saa poistaa.

Älä kytkä audiotehovahvistimen lähtöjä suoraan mihinkään yksikön liittimeen.

Sähköiskun ja palovaaran välttämiseksi yksikkö ei saa olla sateessa tai kosteassa, eikä sitä saa käyttää märässä ympäristössä.

Älä käytä yksikköä jos se on pudonnut, vaurioitunut, kostunut, tai jos sen suorituskyky on huomattavasti muuttunut, mikä vaatii huoltoa.

Yksikön saa avata vain laitteeseen perehtynyt huoltohenkilö. Kansien poisto altistaa sinut vaarallisille jännitteille.



Tämä kolmio, joka esiintyy komponentissasi, varoittaa sinua eristämättömän vaarallisen jännitteen esiintymisestä yksikön sisällä. Tämä jännite saattaa olla riittävän korkea aiheuttamaan sähköiskuvaaran.



Tämä kolmio, joka esiintyy komponentissasi, kertoo sinulle, että tässä tuotedokumentoinnissa esiintyy tärkeitä käyttö- ja ylläpito-ohjeita.

Norsk

Viktig informasjon om sikkerhet

Ta vare på denne veiledningen for senere bruk.

Følg alle anvisningene og advarslene som er angitt på apparatet.

Apparatet skal alltid anvendes med korrekt spenning. Produktbeskrivelsen inneholder spesifikasjoner for strømkrav. Vær oppmerksom på at det ved ulike driftsspenninger kan være nødvendig å bruke en annen ledning- og/eller støpseltype.

Apparatet skal ikke monteres i skap uten ventilasjon, eller direkte over varmeproduserende utstyr, som for eksempel kraftforstærkere. Den maksimale romtemperaturen som står oppgitt i produktbeskrivelsen, skal overholdes.

Apparatet er utstyrt med ventilasjonsåpninger. For at apparatet skal være pålitelig i bruk og ikke overopphetes, må disse åpningene ikke blokeres eller tildekkes. Stikk aldri noe inn i ventilasjonsåpningene, og pass på at det aldri søles noen form for væske på apparatet.

Dette apparatet er utstyrt med et jordet støpsel. Dette er en sikkerhetsforanstaltning som ikke må forandres.

Utgangsplugger fra audioforstærkere skal aldri koples direkte til apparatet.

Unngå brannfare og elektrisk støt ved å sørge for at apparatet ikke utsettes for regn eller fuktighet og ikke anvendes i nærheten av vann.

Apparatet skal ikke brukes hvis det har blitt utsatt for støt, er skadet eller blitt vått, eller hvis endringer i ytelsen tyder på at det trenger service.

Dette apparatet skal kun åpnes av fagfolk. Hvis dekslet fjernes, utsettes man for livsfarlig høyspenning.



Komponenten er merket med denne trekanten, som er en advarsel om at det finnes uisoleret, farlig spenning inne i kabinettet ... høy nok til å utgjøre en fare for elektrisk støt.



Komponenten er merket med denne trekanten, som betyr at den tilhørende litteraturen inneholder viktige opplysninger om drift og vedlikehold.

Svenska

Viktiga säkerhetsföreskrifter

Spara dessa föreskrifter för framtida bruk.

Följ alla anvisningar och varningar som anges på enheten.

Använd alltid rätt nätspänning. Se tillverkarens bruksanvisningar för information om effektkrav. Märkväl, att andra matningsspänningar eventuellt kräver att en annan typs nätsladd och/eller kontakt används.

Installera inte enheten i ett oventilerat stativ, eller direkt ovanför utrustningar som avger värme, t ex effektförstärkare. Se till att omgivningens temperatur vid drift inte överskrider det angivna värdet i produktspecifikationen.

Behållaren är försedd med hål och öppningar för ventilering. För att garantera tillförlitlig funktion och förhindra överhettning får dessa öppningar inte blockeras eller täckas. Inga föremål får skuffas in genom ventilationshålen. Inga vätskor får spillas på enheten.

Produkten är försedd med en jordad 3-trådskontakt. Detta är en säkerhetsfunktion som inte får tas ur bruk.

Anslut aldrig audioeffektförstärkarutgångar direkt till någon av enhetens kontakter.

För att undvika elstöt eller brandfara får enheten inte utsättas för regn eller fukt, eller användas på ställen där den blir våt.

Använd inte enheten om den har fallit i golvet, skadats, blivit våt, eller om dess prestanda förändrats märkbart, vilket kräver service.

Enheten får öppnas endast av behörig servicepersonal. Farliga spänningar blir tillgängliga när locken tas bort.



Denna triangel, som visas på din komponent, varnar dig om en oisolerad farlig spänning inne i enheten. Denna spänning är eventuellt så hög att fara för elstöt föreligger.



Denna triangel, som visas på din komponent, anger att viktiga bruksanvisningar och serviceanvisningar ingår i dokumentationen i fråga.

Deutsch
Wichtige Sicherheitsanweisungen

Heben Sie sich diese Sicherheitsanweisungen auch für später auf.
Befolgen Sie alle auf der Vorrichtung stehenden Anweisungen und Warnungen.
Immer nur mit der richtigen Spannung verwenden! Die Gebrauchsanweisungen des Herstellers informieren Sie über die elektrischen Anforderungen. Vergessen Sie nicht daß bei verschiedenen Betriebsspannungen ggf. auch verschiedene Leitungskabel und/oder Verbindungsstecker zu verwenden sind.
Stellen Sie die Vorrichtung nicht in ein unbelüftetes Gestell oder unmittelbar über wärmeerzeugende Geräte wie z.B. Tonverstärker. Halten Sie die in den Produktspezifikationen angegebene maximale Umgebungstemperatur bei Betrieb ein.
Schlitze und Öffnungen im Gehäuse dienen der Belüftung; um verlässlichen Betrieb sicherzustellen und Überheizen zu vermeiden dürfen diese Öffnungen nicht verstopft oder abgedeckt werden. Stecken Sie nie irgend einen Gegenstand durch die Belüftungsschlitze. Vergießen Sie keine Flüssigkeiten auf den Apparat.
Dieses Produkt ist mit einem 3-drahtigen Erdungsstecker ausgerüstet. Diese Sicherheitsmaßnahme darf nicht unwirksam gemacht werden.
Schließen Sie nie Tonverstärker unmittelbar an einen Anschluß des Apparates an.
Um elektrischen Schlag oder Feuer zu vermeiden, setzen Sie den Apparat weder Regen noch Feuchtigkeit aus und betreiben Sie ihn nicht dort wo Wasser eindringen könnte.
Versuchen Sie nicht den Apparat zu betreiben falls er fallen gelassen, beschädigt, oder Flüssigkeiten ausgesetzt wurde, oder falls sich seine Arbeitsweise derart ändert daß daraus ein Bedarf nach Reparatur zu schließen ist.
Dieser Apparat sollte nur von qualifizierten Fachleuten geöffnet werden. Das Abnehmen von Abdeckungen setzt Sie gefährlichen Spannungen aus.



Dieses Dreieck auf Ihrem Apparat warnt Sie vor nicht-isolierter, gefährlicher Spannung im Gehäuse ... stark genug um eine Berührgsfahr darzustellen.



Dieses Dreieck auf Ihrem Apparat bedeutet daß wichtige Betriebs- und Wartungsanweisungen in der mitgelieferten Dokumentation zu finden sind.

Español
Instrucciones importantes de seguridad

Guarde esta instrucciones para uso posterior.
Utilice siempre el voltaje correcto. Diríjase a las instrucciones de operación del fabricante para obtener las especificaciones de potencia. Esté al tanto de que voltajes de operación distintos requieren el uso de cables y/o enchufes distintos.
No instale esta unidad en un estante sin ventilación, ni tampoco directamente encima de equipos que generen calor tales como amplificadores de potencia. Fíjese en las temperaturas ambientales máximas de operación que se mencionan en las especificaciones del producto.
Las aperturas y ranuras del chasis sirven para proveer la ventilación necesaria para operar la unidad con seguridad y para prevenir sobrecalentamiento, y por lo tanto no pueden ser obstruidas o cubiertas. No introduzca objetos de ningún tipo a través de las ranuras de ventilación, y nunca deje caer ningún líquido sobre la unidad.
Este producto está equipado con un enchufe de 3 clavijas con conexión a tierra. Éste es un elemento de seguridad que no debe ser eliminado.
Nunca conecte ningún tipo de salida de amplificadores de sonido directamente a los conectores de la unidad.
Para prevenir descargas eléctricas o incendios, mantenga la unidad alejada de la lluvia, humedad o cualquier lugar en el que pueda entrar en contacto con agua.
No trate de hacer funcionar la unidad si se ha caído, está dañada, ha entrado en contacto con líquidos, o si nota cualquier cambio brusco en su funcionamiento que indique la necesidad de hacerle un servicio de mantenimiento.
Esta unidad deberá ser abierta únicamente por personal calificado. Si usted quita las coberturas se expondrá a voltajes peligrosos.



Este triángulo que aparece en su componente le advierte sobre la existencia dentro del chasis de voltajes peligrosos sin aislantes ... voltajes que son lo suficientemente grandes como para causar electrocución.



Este triángulo que aparece en su componente lo alerta sobre las instrucciones de operación y mantenimiento importantes que están en los materiales de lectura que se incluyen.

Français
Instructions de Sûreté Importantes

Gardez ces instructions pour référence future.
Observez toutes les instructions et tous les avertissements marqués sur l'appareil.
Branchez uniquement sur un réseau de tension indiquée. Consultez le manuel d'instruction du fabricant pour les spécifications de courant. N'oubliez pas que différentes tensions peuvent nécessiter l'utilisation de cables et/ou de fiches de connexion différents.
N'installez pas l'appareil en un compartiment non-aéré ou directement au-dessus d'équipements générateurs de chaleur, tels qu'amplificateurs de courants, etc. Ne dépassez pas la température ambiante maximale de fonctionnement indiquée dans les spécifications du produit.
Des fentes et ouvertures sont prévues dans le boîtier pour l'aération; Pour assurer le bon fonctionnement et pour prévenir l'échauffement, ces ouvertures ne doivent pas être couvertes ou bloquées. N'insérez pas d'objets dans les fentes d'aération. Empêchez tout liquide de se répandre sur l'appareil.
Ce produit est muni d'une fiche à trois fils pour la mise à terre. Ceci est une mesure de sécurité et ne doit pas être contrariée.
Ne connectez jamais d'amplificateurs audio directement aux connecteurs de l'appareil.
Pour empêcher les chocs électriques et le danger d'incendie, évitez d'exposer l'appareil à la pluie ou à l'humidité, et ne le mettez pas en marche en un endroit où il serait exposé aux éclaboussures d'eau.
N'essayez pas de faire fonctionner l'appareil s'il est tombé à terre, a été endommagé, exposé à un liquide, ou si vous observez des différences nettes dans son fonctionnement, indiquant la nécessité de réparations.
Cet appareil ne doit être ouvert que par un personnel de service qualifié. En enlevant les couvercles vous vous exposez à des tensions électriques dangereuses.



Ce triangle, sur votre appareil vous avertit de la présence de tension dangereuse, non-isolée à l'intérieur du boîtier...une tension suffisante pour représenter un danger d'électrocution.



Ce triangle sur sur votre appareil vous invite de suivre d'importantes instructions d'utilisation et d'entretien dans la documentation livrée avec le produit.

Italiano
Importanti norme di sicurezza

Conservare le presenti norme per l'utilizzo futuro.
Osservare tutte le istruzioni e le avvertenze apposte sull'unità.
Utilizzare esclusivamente con la tensione di rete corretta. Consultare le istruzioni operative fornite dal fabbricante per i dati riguardanti la tensione e l'assorbimento di corrente. Potrebbe essere necessario l'uso di cavi di rete e/o di spine diverse a seconda della tensione utilizzata.
Non installare l'unità in uno scaffale privo di ventilazione oppure direttamente sopra una fonte di calore, come, ad esempio, un amplificatore. Non superare la temperatura ambientale massima di funzionamento riportata nei dati tecnici del prodotto.
Le fessure e le altre aperture nella scatola servono alla ventilazione. Per un funzionamento affidabile, e per evitare un eventuale surriscaldamento, queste aperture non vanno ostruite o coperte in nessun modo. Evitare in tutti i casi di inserire oggetti di qualsiasi genere attraverso le fessure di ventilazione. Non versare mai del liquido di nessun tipo sull'unità.
Questo prodotto viene fornito con una spina a 3 fili con massa. Tale dispositivo di sicurezza non va eliminato.
Evitare sempre di collegare le uscite dell'amplificatore audio direttamente ai connettori dell'unità.
Per prevenire il pericolo di folgorazione e di incendio non esporre l'unità alla pioggia o ad un'umidità eccessiva; evitare di adoperare l'unità dove potrebbe entrare in contatto con acqua.
Evitare di adoperare l'unità se la stessa è stata urtata violentemente, se ha subito un danno, se è stata esposta ad un liquido o in caso di un evidente cambiamento delle prestazioni che indichi la necessità di un intervento di assistenza tecnica.
Ogni intervento sull'unità va eseguito esclusivamente da personale qualificato. La rimozione della copertura comporta l'esposizione al pericolo di folgorazione.
Il presente triangolo impresso sul componente avverte della presenza di tensioni pericolose non isolate all'interno della copertura... tali tensioni rappresentano un pericolo di folgorazione
Il presente triangolo impresso sul componente avverte l'utente della presenza nella documentazione allegata di importanti istruzioni relative al funzionamento ed alla manutenzione.



Il presente triangolo impresso sul componente avverte della presenza di tensioni pericolose non isolate all'interno della copertura... tali tensioni rappresentano un pericolo di folgorazione



Il presente triangolo impresso sul componente avverte l'utente della presenza nella documentazione allegata di importanti istruzioni relative al funzionamento ed alla manutenzione.

Contents

Introduction

1. Product Overview

The Front Panel	1-1
The Rear Panel	1-2
Installation Notes	1-3
Mounting	1-3
Power Requirements	1-3
Audio Connections	1-4
Analog Audio • Digital Audio • Mono Applications	
Footswitch/Footpedal • MIDI	
Setting Audio Levels	1-4
Headroom Display • Rear Panel Input Level Switch	
Overload • Setting the Input Mode • Using Soft Sat	
Setting Input Level • Setting Output Level	
Configuration	1-8

◀ Look here for information on setting levels and hooking up to other equipment.

2. Basic Operation

MPX 1 Menus	2-1
Loading and Playing with Programs	2-2
Program Load	2-2
Effect Bypass	2-3
Mix	2-3
Tap	2-4
A/B	2-4
Soft Value Editing	2-5
Program Sort, Search and Show - Using the DataBase	2-6
Program Store	2-7
MPX 1 Preset Summary	2-8

◀ Easy operation of the MPX 1 — loading, playing with, and storing programs, plus a list of the Presets.

3. Editing

Effect Editing	3-1
The MPX 1 Edit Menus	3-3
Compare	3-3
Meter Assign	3-4
Copy Effect	3-5
Soft Row Parameter Assignment	3-6
Tempo	3-6
Rate • Source • Beat Value • Tap Average • Tap Source	
Tap Source Level	
DataBase — Assigning DataBase Source and Effect types	
to the current program	3-8
Routing Map	3-9
How to change routing connections • How to change routing	
options • Routing Example • Notes and Tips on Routing	
Effect Order	3-13
Setting the Parameters of the Internal Controllers	
(Knob, LFO 1 and 2, Arpeggiator, ADR 1 and 2, Random,	
A/B, Sample & Hold, Env 1 and 2)	3-14

◀ Check here for information on editing Effects and programs.

Contents, cont'd.

**All about the MPX 1
Patch System** ▶

**Complete details on all
of the MPX 1 System
parameters** ▶

4. Patching	
Patch Jump from Edit Mode	4-2
Selecting a Source and Destination	4-2
Changing the Range of the Source Controller	4-3
Viewing Source Controller Activity	4-3
MIDI Learn — Automatic Controller Assignment	4-4
Copying Patches	4-4
Changing the Range of the Destination Parameter	4-5
Linear or Nonlinear Control	4-6
Suspending and Clearing Patches	4-7
Multiple Patches with the Same Destination	4-7
5. System Controls	
The System Menus	5-1
Audio Controls	5-2
Input/clock	5-2
Error Log and Status	
Input Mode	5-2
Output Mode	5-2
Dig In Lvl	5-3
ChanStatus	5-3
Soft Sat	5-3
Modes	5-3
Pgm Load	5-3
Mix	5-4
Bypass	5-4
Bypass Source Assignments	
Pgm Bypass	5-4
Tempo Mode	5-5
Memory Protect	5-5
StorePrompt	
Contrast	5-5
Sleep	5-5
Setup Load and Setup Store	5-6
MIDI	5-8
Program Change	5-8
Pgm# Offset, Pgm+ and Pgm-	
Receive	5-8
Transmit	5-8
Ctl Send	5-8
MIDI Reset	
Ctl Smooth	5-9
Clock Send	5-9
Automation	5-9
Xmit Device ID	
SysEx	5-9
Receive Device ID	
Dump	5-10
Xmit Speed	
MIDI Maps	5-10
Program Chains	5-11
Initialize	5-12
Clear Programs	5-13
Copy Programs	5-14

Global Patches	5-15
MIDI Learn and Dst Edit	5-15
Calibrate Pedal	5-16

Contents, cont'd.

6. MIDI Operation

Selecting a MIDI Channel	6-1
Accessing Programs	6-1
Controlling MIDI Tempo Rate with MIDI Clock	6-2
MIDI Tempo Control	6-2
Using the MPX 1 as a MIDI Clock Source	6-2
Slaving two or more MPX 1s	6-3
Controller Quirks	6-4
The Knob, Footpedal and Footswitch as MIDI Controllers	6-4
The Arpeggiator	6-5
Program Change Messages	6-6
Automation	6-7
SysEx Automation	6-7
Controller Automation	6-7
Reset All Controllers	6-7
MIDI Clock and Clock Commands	6-7
Dynamic MIDI	6-8
Bulk Data Dumps	6-8
MIDI Implementation Chart	6-9

◀ Information on working with MIDI

7. The Effects and Parameters

Notes on Combining Effects	7-2
Notes on Controlling Effect Parameters	7-2
Notes on the Effect Descriptions	7-2
Pitch Effects	7-3
Detune (M), Detune (S) and Detune (D)	7-3
Shift (M), Shift (S) and Shift (D)	7-4
Volume (M), Volume (S) and Volume (D)	7-4
Test Tone	7-5
Chorus Effects	7-6
Chorus	7-6
Flanger (M) and Flanger (S)	7-7
Phaser	7-7
Rotary Cab	7-8
Aerosol	7-8
Orbits	7-9
Centrifuge1 and Centrifuge2	7-10
Comb 1 and Comb 2	7-11
EQ Effects	7-12
1-Band (M), 2-Band (M), 3-Band (M) and 4-Band (M)	7-14
1-Band (S) and 2-Band (S)	7-14
1-Band (D) and 2-Band (D)	7-14
SweepFilter	7-15
Wah	7-15
Fc Splitter	7-16
Crossover	7-16
The 2-Tone and 3-Tone Effects	7-17
2-Tone (M), 2-Tone (S) and 2-Tone (D)	7-17
3-Tone (M), 3-Tone (S) and 3-Tone (D)	7-18

◀ Complete details on all of the MPX 1 Effects

Contents, cont'd.

Mod Effects	7-19
Panner	7-19
Auto Pan	7-19
Tremolo (M) and Tremolo (S)	7-20
Overdrive	7-20
Volume (M), Volume (S) and Volume (D)	7-21
Delay Effects	7-22
Delay (M), Delay (S) and Delay (D)	7-23
Echo (M), Echo (S) and Echo (D)	7-24
Looper	7-25
Ducker	7-25
Reverb Effects	7-26
Chamber	7-26
Hall	7-26
Plate	7-27
Gate	7-27
Ambience	7-28

8. MPX 1 Internal Controllers

Knob	8-1
LFO1 and LFO2	8-1
Arpeggiator	8-2
ADR1 and ADR2	8-3
Random Generator	8-3
A/B Glide	8-4
S/H	8-5
Env1 and Env2	8-5
Footswitch Controllers	8-6

Complete descriptions of
the MPX 1 Internal
controllers

9. Preset Descriptions

Complete descriptions of
the MPX 1 presets

10. Troubleshooting

Low Voltage	10-1
Overheating	10-1
Common MIDI Problems	10-1
Operational Problems	10-2
Power On Behavior	10-2

Check here for solutions to
common problems

11. Specifications

Thank you for your purchase of the MPX 1, the vanguard of Lexicon's latest line of effects processors. The MPX 1 multi processor technology gives you multi effects the way you expect them to work — with instant access to individual effects, and the ability to run uncompromised stereo reverb at all times. In addition to the superb sonic quality you expect from Lexicon, the MPX 1 gives you easy, top level control over even the most complex functions, and visual feedback to let you know exactly where you are and what features are available at all times.

Six primary effect types: Pitch, Chorus, EQ, Modulation, Delay and Reverb give you push button access to an arsenal of 57 effects. 200 presets make maximum use of these effects in combination — using as many as 4 stereo effects *in addition to* uncompromised stereo reverb.

The preset library is organized under database control to allow you to quickly find programs designed for specific sources such as Guitar, Vocals or Live Performance, or to find all of the programs using certain effects such as Pitch or EQ.

Be sure to experiment with all 200 presets to get a feel for the full range of MPX 1 capabilities.

Visual feedback is available every step of the way when you're using the MPX 1, with lighted buttons indicating the state of the unit and alerting you to extra features available from the front panel. A large numeric display shows program (and patch) numbers. A second alphanumeric display shows you program and parameter names and settings.

Like all Lexicon processors, the MPX 1 gives you as much depth of control as you're ever likely to want, while keeping the details out of your way. Surface control of the MPX 1 is straightforward and intuitive, with the most useful parameters of every program available right in Program mode. In addition to this specially designed "soft row", common functions and controls are brought right out to the front panel for instant access.

For example, Mix and Level controls, for the entire system, or for any individual effect, can be accessed at any time by pressing the front panel **Mix** button. The front panel **Patch** button, which gives you similar instant access to the Patching system, lights whenever a patched parameter is selected to remind you that you can jump right in and out of the patching system at will.

The MPX 1 gives you tap tempo control when you want it. You can assign tempo control to modulation rates, delay times or any effect parameter, ensuring that your effects are in tempo with your music. Tempos can be tapped in with the front panel **Tap** button (or an assigned controller) or "dialed-in", in BPM (beats per minute) on the display. The MPX 1 also lets you generate MIDI clock from your tempo, as well as receive MIDI tempo from an external sequencer or drum machine. Many presets have delay times assigned to Tap tempo. Try loading some of these. (Select source type: Tempo in the database to find all of them.) When you load a tempo driven program, the front panel **Tempo** LED will flash at the current tempo to let you know the **Tap** button is active. Press **Tap** twice in rhythm to change tempo.

Introduction

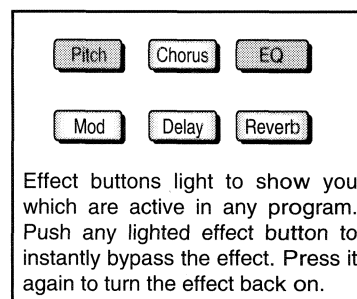

Effect buttons light to show you which are active in any program. Push any lighted effect button to instantly bypass the effect. Press it again to turn the effect back on.

Database Sorting Options

Sort selections by:

- name
- number
- source type:
 - Acoustic
 - Drums
 - Guitar
 - Keyboard
 - Live PA
 - Tempo
 - Sound FX
 - Vocal
- effect type:
 - Pitch
 - Chorus
 - EQ
 - Mod
 - Delay
 - Reverb:
 - Ambient
 - Chamber
 - Plate
 - Hall
 - Inverse
 - Gate
 - Dual
- source & effect type
- members of MIDI maps
- members of pgm chains
- last 10 programs loaded

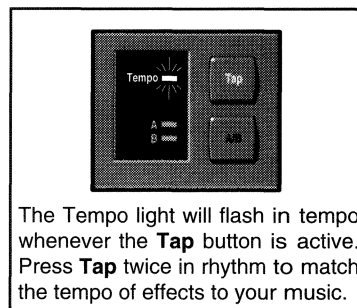

The Tempo light will flash in tempo whenever the **Tap** button is active. Press **Tap** twice in rhythm to match the tempo of effects to your music.

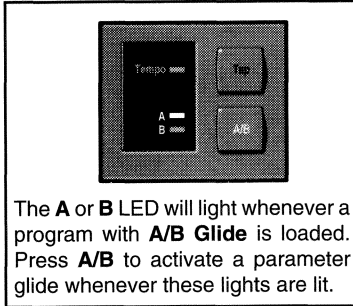

An A/B glide function is also available from the front panel — and of course we've designed presets to show this function off to its fullest. Whenever the **A** or **B** LED is lit, press the A/B button to activate the glide.

When you want to create your own versions, you'll find A/B available as an internal controller in Edit mode along with two LFOs, a MIDI arpeggiator, two ADRs, Envelopes, and more.

Complete editing control is provided under the Edit button, where you can customize presets or make new ones from scratch, design your own soft row parameters, copy effects into new programs, and put effects in any sequence or routing configuration you want. Easy access to all of the parameters of any effect is just a button push away.

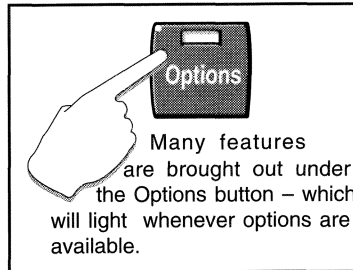

All of the front panel functions (Tap, A/B, Effect selection, etc.) can easily be connected to MIDI controllers, footswitches, or footpedals, letting you set up all of the functions the way *you* want them.

About the manual

We designed the MPX 1 to be simple to use, and have provided a quick reference card to show you around the main features, but to get the most out of the MPX 1, we suggest that you invest the time to explore this manual. We think you'll agree that the time spent investigating will reward you with enjoyment of its full capabilities.

To get off to a quick start, turn directly to Chapter 1 *Product Overview* and Chapter 2 *Basic Operation*. The first section provides button definitions and necessary information for setting audio levels and connecting to other equipment. The second will tell you everything you need to know about loading and playing with programs.

When you want to know more, check out the Table of Contents. We've divided topics into many easy to read (or skip) chapters so that you can find what you need without wading through what you don't.

When the MPX 1 is left idle for any length of time, a "Sleep" mode is activated. In this mode, a set of messages is cycled across the display. When shipped, the Sleep mode is set to "English Promo" for display of MPX 1 features. You can change this mode to display features in other languages, Help messages which give you general information, or you can turn off the messages completely. To select the mode you want: press **System**. Use the knob to select **Modes**, then use the < and > buttons to select **Sleep**. Use the knob to select **Off**, **Help** or **Promo** in English, French, German, Italian or Spanish.

Product Overview

The Front Panel

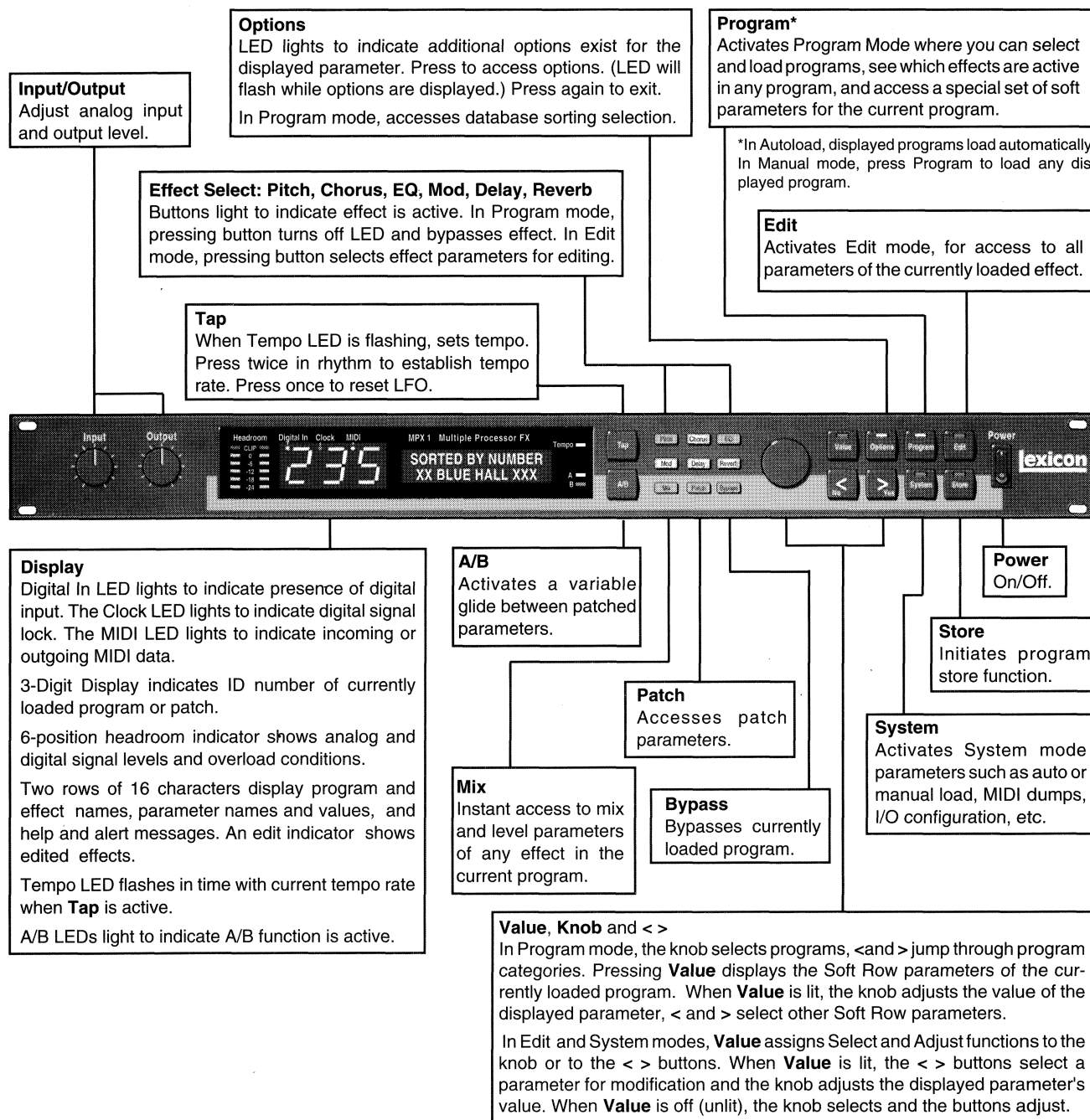

The Rear Panel

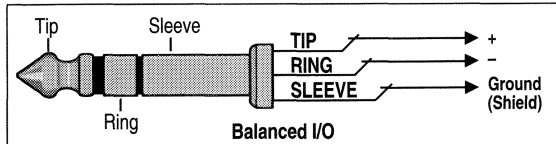
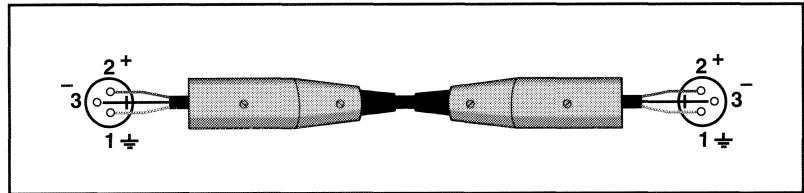

Balanced Inputs

Input impedance is 50kΩ unbalanced, and 100kΩ balanced. Inputs accept input levels from -14dBu to +20dBu. 1/4" phone connectors and XLRs provided.

Input Level

2-position (In/Out) switch for matching input gain to the source being used. The In position adds 12dB of input gain (unbalanced) to the input stages. Out position provides 0dB of gain (balanced).

Balanced Outputs

Output impedance is 600Ω, each side, balanced, and levels up to +18dBu maximum full scale. 1/4" phone connectors and XLRs provided.

S/PDIF

S/PDIF format digital connectors conform to CP-340 Type II consumer standards. (44.1kHz only)

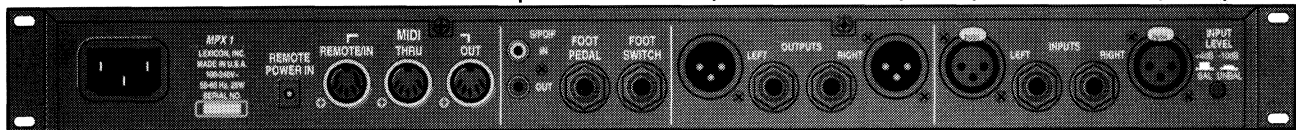

REMOTE POWER IN

2.5mm connector for 9 VAC MIDI remote power.

Foot Pedal

1/4" Tip/Ring/Sleeve phone jack provided for footpedal with 10kΩ to 100kΩ impedance.

AC Power

Standard 3-pin IEC power connector. 100-240V, 50-60Hz automatic switching to correct voltage range.

Foot Switch

1/4" Tip/Ring/Sleeve phone jack for three independent footswitches.

MIDI

IN

7-pin DIN connector for MIDI IN or powered bidirectional MIDI remote.

THRU

5-pin DIN connector passes any MIDI data received without change.

OUT

5-pin DIN connector transmits MIDI data to other equipment.

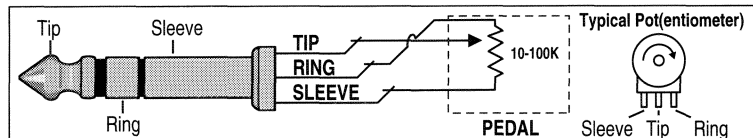
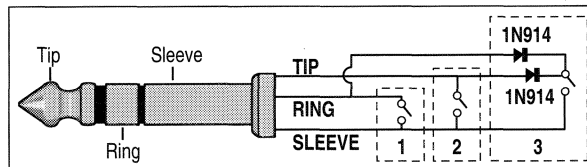

For control voltage input, use a 1/4" stereo plug with Sleeve connected to ground, Tip connected to the control voltage, and Ring unconnected.

Installation Notes

The MPX 1 uses one EIA-standard rack space, and can be mounted on any level surface or in a standard 19 inch (483 mm) rack. If the unit is mounted in a rack or road case, support the rear of the chassis to prevent possible damage from mechanical shock and vibration.

The maximum ambient operating temperature is 104°F (40°C). Provide adequate ventilation if the unit is mounted in a closed rack with heat-producing equipment such as power amplifiers.

The MPX 1 is equipped with a 3-pin IEC power connector and detachable cord. The unit will operate with power sources from 100 to 240 volts AC, 50-60Hz. Power switching to actual line voltage is automatic.

Analog Audio

For best performance, maintain balanced connections, and use high-quality, low-capacitance, twisted-shielded pair cable.

When connecting MPX 1 outputs to single-ended, unbalanced devices, leave the low side floating and connect the grounds between the units.

Digital Audio

Connectors are provided for S/PDIF (CP-340 Type II) Consumer Digital Audio I/O. 75Ω coaxial cable suited for digital audio or video signals is required. Audio grade cable is *not* suitable. Only 44.1kHz signals are recognized.

Mono Applications: Using the MPX 1 Inputs with a Mono Source

Many of the programs in the MPX 1 are designed to process stereo input signals. These programs will also work and sound great with mono signals - but you need to configure the unit for mono. It will not automatically compensate for single-wire mono input connections.

There are two ways to use the MPX 1 in an installation where its inputs will be driven from a single, mono source:

- Use a Y-connector to send the signal to both inputs.
- Connect the mono signal to either the Left or Right input connector, then change the **System mode Audio Input Mode** parameter. If the Left input is connected, change the setting to **Mono (L only)**. If the Right input is connected, change it to **Mono (R only)**. The Mono settings of this parameter apply to the S/PDIF digital inputs as well. This allows you to select either the left or the right digital channel for processing.

NOTE

Individual programs can be optimized for mono input by simply inserting a mono effect, such as **Volume (M)**, into the first block of the routing map. See Chapter 3: *Editing* for more information on routing. See Chapter 7: *The Effects and Parameters* for more information on individual effects.

Mounting

Power Requirements

Audio Connections

Mono Applications: Using the MPX 1 Outputs with Mono Return

Virtually all of the MPX 1 programs generate stereo or dual output signals, even when driven by a mono source. For the best sonic results, the MPX 1 outputs should be connected in stereo. If you are using the MPX 1 in a mono system with only a single input, use a simple 2 x 1 mixer or a Y-connector to combine both outputs.

NOTE

Individual programs can be optimized for mono input by simply inserting a mono effect, such as **Volume (M)**, into the last block of the routing map. See Chapter 3: *Editing* for more information on routing. See Chapter 7: *The Effects and Parameters* for more information on individual effects.

Be careful to keep input and output to all channels wired consistently. Out-of-phase wiring can produce audible effects.

Footswitch/Footpedal

One 1/4 inch T/R/S phone jack is provided for 3 momentary footswitches. Another 1/4 inch T/R/S phone jack is provided for a footpedal (minimum 10k to maximum 100k impedance). Normally open or normally closed momentary switches are suitable. At power on, the MPX 1 assumes the switch is off. Use shielded, twisted-pair cable with shield connected to sleeve. See diagram on previous page. See also Chapter 5: *System Controls* for information on pedal calibration.

MIDI

5-pin DIN connectors are provided for MIDI THRU and OUT. A 7-pin DIN connector is provided for MIDI IN or a powered remote. Use standard MIDI cable assemblies, available from your local dealer.

Setting Audio Levels

The MPX 1, with both analog and digital input and output connections, requires some attention to proper setting of signal level.

Analog inputs are first gain-conditioned by the rear panel input level switch, and then by the front panel Input knob. Proper setting of both the switch and knob are important for best performance of the A/D converter.

Analog and digital sources are selected in System mode on the Input/Click screen of the Audio menu. The selections are: **Analog/Int**, **Analog/Ext** and **Dig/Ext**.

Proper setting of Input level is dependent on:

- Proper signal level into the analog front end to avoid signals causing overload at the Digital Signal Processing (DSP) input (rear panel Input button)
- Proper adjustment of the signal level into the analog-to-digital converter to optimize noise and avoid overload (front panel Input knob)
- Proper setting of signal level within the digital signal processor to optimize noise (Lvl parameter in each effect block)

Digital input level is adjustable from the **Dig In Lvl** screen of the **Audio** menu in **System** mode. Level can be set to **Off, -89dB to +6db** to optimize noise and avoid overload.

Headroom Display



The headroom display provides both headroom and overload information from a variety of measurement points.

The information on the headroom display is selectable from the Meters Assign menu in Edit mode and the assignment made here is saved as a part of each program. The available assignments are:

- Inputs
- Outputs
- InLevel, OutLevel or In&OutLevel for all effect blocks. (when In&Out is selected, the left side of the headroom display will display InLevel and the right side of the headroom display will display OutLevel.)
- LFO 1 and LFO 2 (Left and right sides of the display)
- Envelope 1 and Envelope 2 (Left and right sides of the display)
- Footpedal
- ADR 1 and ADR 2 (Left and right sides of the display)
- Simulation display (for test purposes)

Rear Panel Input Level Switch

The chart below illustrates the adjustment range that will set input levels for both balanced and unbalanced operation. When a choice can be made, it is best to operate at the higher amplitude end of the recommended range to optimize noise performance.

	 Unbalanced (-10)	 Balanced (+4)
overload:	> +8dBu	>+20dBu
acceptable:	8dBu to -14dBu	+20dBu to -2dBu
too low (noisy):	<-14dBu	<-2dBu

Overload

The Clip (overload) indicators will light under the following conditions:

- Analog-to-Digital (A/D) overload
- overload at any point in effects processing within .1dB of maximum
- input level within .1dB of maximum

For example, internal peaking of high Q filters, or level buildup from certain reverberation modes can result in overload, even when the input A/D or digital receiver data stream is not at full scale. Such conditions are most often caused by a combination of extreme parameter settings. Adjusting parameter/level settings can eliminate these overload conditions.

Setting the Input Mode

The MPX 1 can be set for stereo input, mono left input or mono right input. To set the mode, press **System**, select **Audio**, then select **Input Mode**. If cables are connected to both XLR and 1/4" connectors, the 1/4" inputs will override and disable the XLR inputs. Selecting either Mono setting routes the selected audio input channel (left or right) to both left and right DSP signal paths. (This is true for both digital and analog inputs.)

Using Soft Sat

Soft Sat is a built-in analog limiter that precedes the A/D converters in the MPX 1. If the source to the MPX 1 is "hot", you can use **Soft Sat** to reduce the harshness caused by overloading the A/D converters. Press **System**, select the **Audio** menu, then select **Soft Sat** to turn the limiter **On** or **Off**.

Setting Input Level

1. Set the rear panel Input button to the appropriate position for balanced or unbalanced operation.
2. Press **Edit** and scroll to the **Meters Assign** parameter. Make sure that the meter assignment is **Input** (the default setting).
3. Press **System**.
4. Select the **Audio** menu and scroll to the **Input/Click** screen.
5. Select the desired input mode.
6. If you have selected **Analog/Int** or **Analog/Ext**, run audio through the unit and adjust the front panel Input knob so that program material peaks cause the headroom display to reach the top of the column without lighting the Clip indicators. An occasional peak which momentarily lights the Clip indicators is acceptable in most instances, but should be validated by listening to the actual result. If the the 0dB headroom indicator illuminates frequently, you may want to use the Soft Sat limiter to reduce overload of the A/D converters. Press **System**, select the **Audio** menu, then select **Soft Sat** to turn the limiter **On** or **Off**.

If you have selected **Dig/Ext**, scroll to the **Audio Dig In Lvl** screen and adjust the level so that program material peaks cause the headroom display to reach the top of the LED column without ever lighting the Clip indicators.

The meters are calibrated to light the Clip indicators at a level of ≥ 0.1 dBfs. For digital inputs, a very brief flashing of the Clip indicators means that you have reached, or are dangerously close to digital clipping.

Setting Output Level

1. Press **System** and select the **Audio** menu.
2. Scroll to **Audio Output** and select **Analog** or **Digital**.
3. Press **System** again and select the **Modes** menu.
4. Scroll to **Modes: Bypass** and make sure that the assignment is **Bypass** (the default setting).
5. Press the front panel **Bypass** button. The button will light to indicate that bypass is engaged.
6. Press **Edit**, scroll to **Meters Assign** and select **Output**.
7. Run audio through the unit and use the front panel Output knob to set the level on your console or amplifier.

The signal level from the 1/4" and XLR outputs is +4dBu. If you have both 1/4" and XLR cables attached to the output connectors, there will be no change in level unless you are driving very low impedance loads (600 Ω), where an attenuation of output level may occur.

Configuration

Connection to a mixing console's effects sends

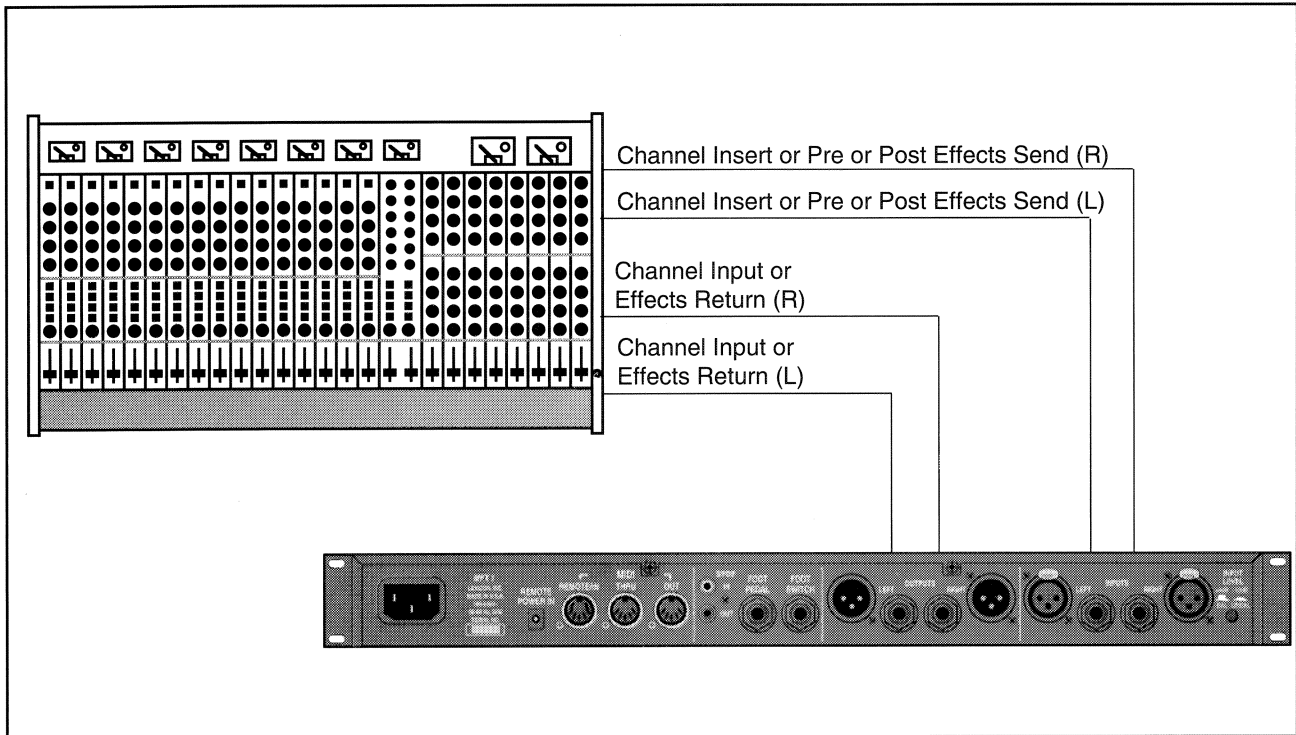

If you will be using the MPX 1 as your primary effects unit, and your system includes a console with one or more auxiliary (effects) sends, connect the units as shown above.

Use channel inserts or prefader sends for best results with programs that are not delay-based or reverb-based (**Rotary Cab**, **Telephone**, **GuitarCabEQ** etc.).

In most applications, it is preferable to connect the MPX 1 outputs to two of the console's input channel strips, panned full left and right, rather than to the effects returns. This allows the greatest flexibility in routing and equalization.

In this configuration the console controls are used to set the amount of effect heard—the MPX 1 **Mstr Mix** control should be set to 100%.

This section is provided to get you up and running on the MPX 1 in the shortest possible time. Beginning with a menu tree to guide you through the major areas of the MPX 1, this chapter focuses on the basics that you want to get to first — finding, loading, tweaking and storing programs.

Basic Operation

MPX 1 Menus

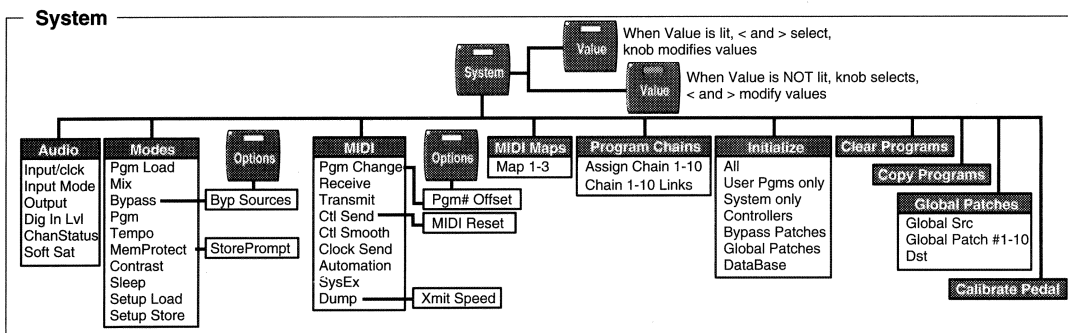
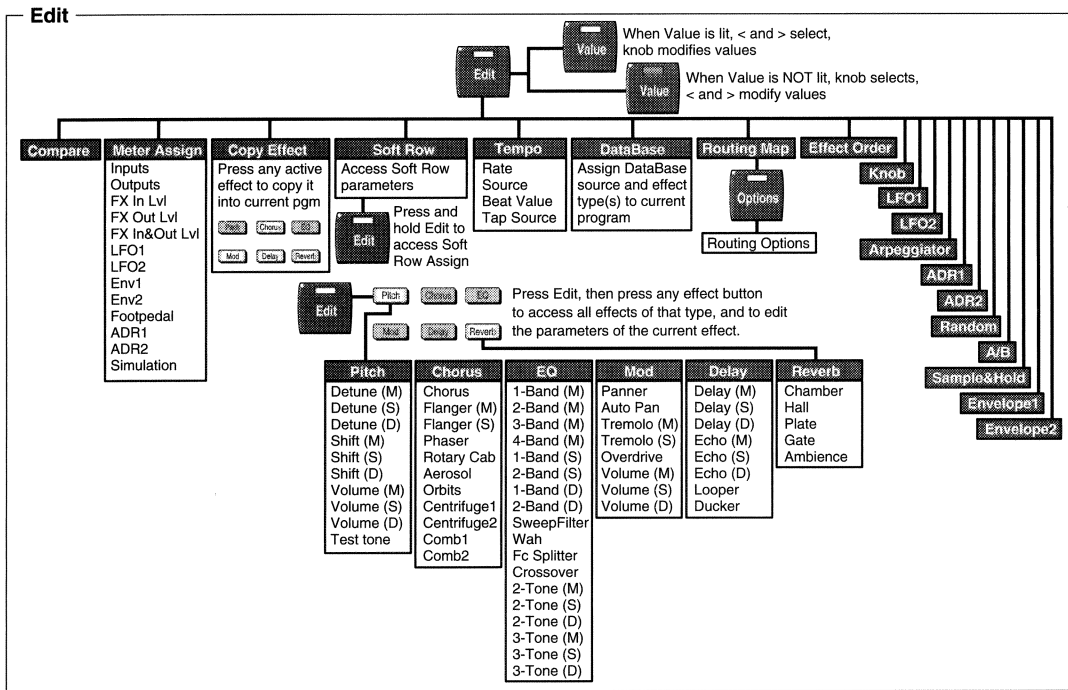
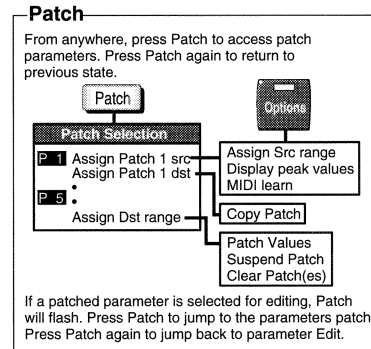
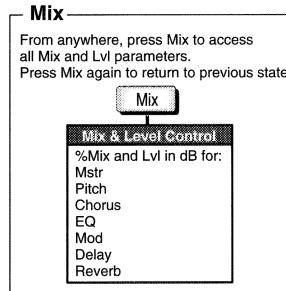
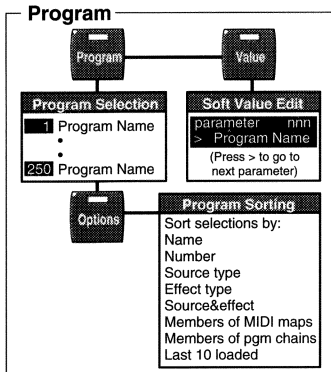

Loading and Playing with Programs

Pressing the front panel **Program** button accesses the MPX 1 library of 250 presets and user programs. In this mode, you can select and load programs, select database sorting criteria and access the "Soft Row" — a selected set of the most useful parameters for each program. You can also access Tap, A/B, Mix and Patch functions, as well as selecting and bypassing effects in the program. Each of these is described in this section.

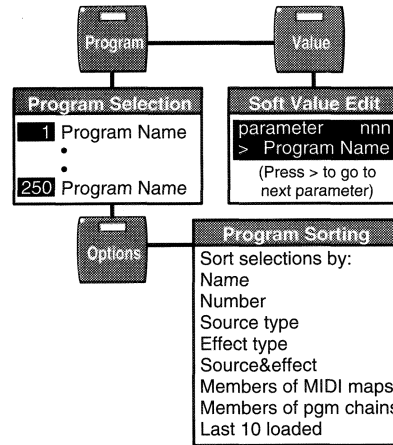
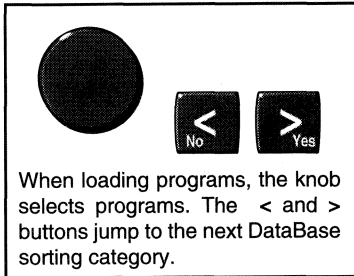

Program Load

When you press the **Program** button, its LED will light to let you know you're in Program mode.

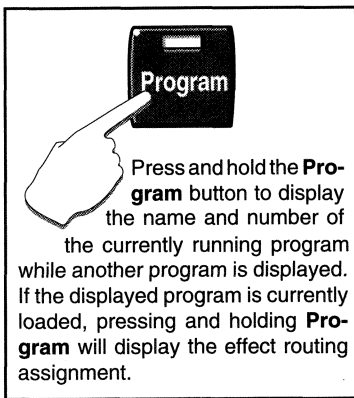

Auto Load

When first shipped, the MPX 1 will default to automatic program load, with all of the programs available in numerical order from 1 to 250. The top line of the display will show the DataBase sorting option "Sorted by number". The bottom line of the display will show a program name. The large numeric display will show the ID number of the displayed program.

Turn the knob to display and load other programs.

Manual Load

To switch to manual program load, press **System**. Use the knob to select **Modes**, then use the < and > buttons to display:

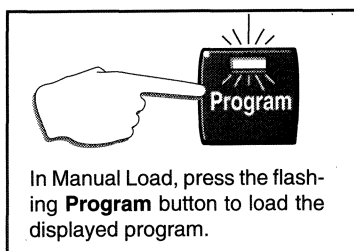
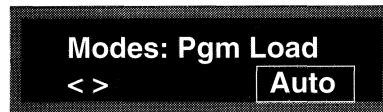

Turn the knob to select **Manual**. In this mode, an asterisk (*) before the program name indicates that the displayed program is not loaded, and the flashing **Program** button LED indicates that the program is cued for loading when **Program** is pressed. (When the currently loaded program is selected, the **Program** button LED will light steadily, and there will be no asterisk in the display.)

The front panel Effect buttons light to show you which effect blocks are active. — When you're scrolling through programs, they'll change to show you the effects in any displayed program. Once you stop scrolling, they'll return to display of the effects that are active in the currently loaded program.

To bypass any active effect, press its button. The light will turn off and the effect will be bypassed. Press the button again to make the effect active again.

Press and hold down any effect button to display the name of the effect and information about its status in the program (on or off).

Effect Bypass

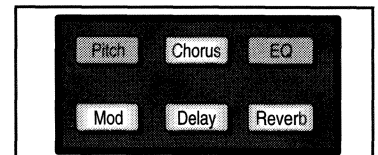

The active effects of the currently loaded program are lighted. Press any lighted button to turn the effect off. Press it again to make the effect active again.

Mix and level controls in the MPX 1 are brought right out to the front panel for easy access. From any mode of operation, just press **Mix** to access these controls. The button LED will flash to let you know **Mix** is active.

The display will show mix and level labels on the upper line, and the current settings on the lower line. One of the values on the lower line will be flashing to let you know which is selected for adjustment. Use the < and > buttons to select **Mstr Mix**, **Mstr Level**, or to step to the Mix and Level controls for any active effect in the currently running program. Use the knob to adjust the flashing parameter value.

Use > to step to the **Mstr Level** parameter, or to step forward to the next screen of Effect Mix and Level parameters.

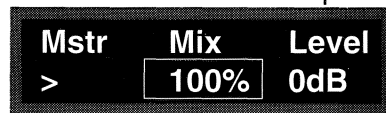

The knob will adjust the flashing parameter value.

When you've finished adjusting the mix and level controls, push **Mix** to return to the previous display.

Mix

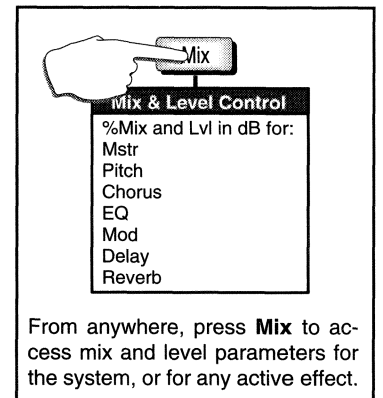

From anywhere, press **Mix** to access mix and level parameters for the system, or for any active effect.

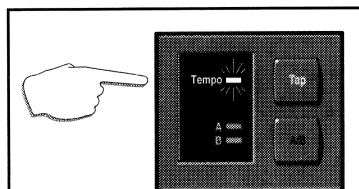
Tap

Flashing of the Tempo LED indicates that **Tap** is active. Press **Tap** twice in rhythm to change the tempo of delay or modulation parameters in the current program.

MPX 1 tempo controls are available right on the front panel through the Tempo LED and the **Tap** button. Many preset programs are designed with their own tempo rate settings which are stored with the programs. The front panel **Tempo** LED will flash in tempo whenever you load a program with tempo control. This flashing indicates that the **Tap** button is active, allowing you to change tempo on the fly. Whenever you see the **Tempo** light flashing, simply press **Tap** twice in rhythm to establish the rate you want.

You can override these individual tempo rates with a global tempo rate in the System Setup menu. Tempo is also available as an independent patch source which can control any effect parameter. (See Chapter 4: *Patching* and Chapter 5: *System Controls*.)

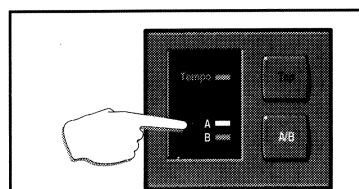
A/B

When **A** is lit, pressing the **A/B** button activates a parameter glide. Pressing **A/B** again reverses the glide.

A/B is a unique glide function which allows you to morph between selected parameters. Most effect parameters (or groups of parameters) can be patched to the A/B controller. Once a parameter is patched, the A/B controls in Edit mode allow you to select the rate at which you want to glide from A to B and from B to A when the front panel **A/B** button is pressed. You can also assign the glide function to be triggered by any internal source, such as input level, or by an internal or external controller.

Many of the presets are designed with A/B patches that allow you to morph between two effects, glide from slow to fast rotary speakers, start and stop loop delays, etc. Loading any program with A/B control assigned, will cause the front panel **A** LED to light, indicating that the A/B function is active. Press **A/B** to activate a glide from the parameter values assigned to **A** to the parameter values assigned to **B**. Press **A/B** again to glide back to the **A** parameter values. (When you want to change the A/B parameters, control A/B remotely, assign a trigger source, or alter the rate of glide, refer to Chapter 4: *Patching* and Chapter 8: *MPX 1 Internal Controllers*.)

Soft Value Editing

The MPX 1 offers access to the most useful parameters of any program *without* having to enter a separate Edit mode. These parameters are available from Program mode in a "Soft Row" which is accessed by pressing **Value**.

From Program mode, simply press **Value** to display one of the Soft Row parameters of the currently loaded program.

The upper line of the display will show the Effect type, the parameter name and the current parameter value. The lower line of the display will show the name of the program. Use the knob to change the parameter value. Use the < and > buttons to move back and forth between the available parameters. A scroll indicator in the lower left corner of the display tells you whether or not there are more parameters in either direction.

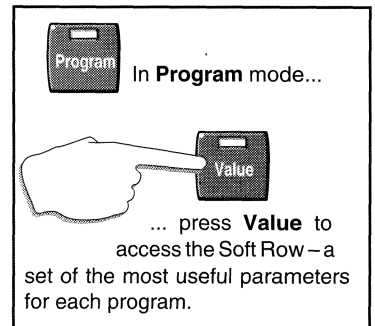

With **Program** and **Value** lit, MPX 1 Soft Row parameters will be displayed. The Effect type and the parameter name will appear on the upper line.

The parameter value will flash in the upper right. Use the knob to change the parameter value, use < and > to select another parameter screen.



The Program name appears on the bottom line, along with scroll indicators (< and >) that point you in the direction of additional screens.

Changes you make to parameters in the Soft Row will be saved only until you load another program unless you store your modified version of the program. See *Program Store* later in this section.

Program Sort, Search and Show — Using the DataBase

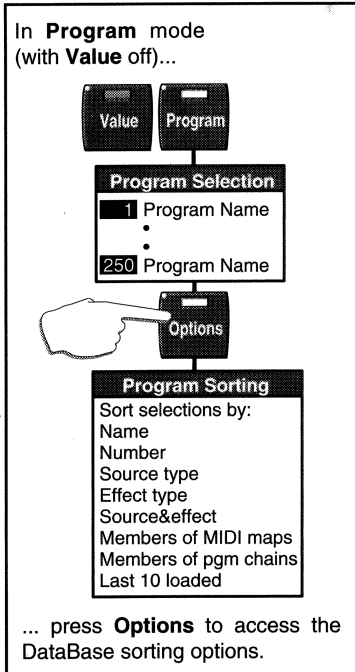

The MPX 1 has a database sorting function which allows you to sort and search for programs in various categories. This is a great timesaver when you're looking specifically for guitar effects, or EQ effects, or for EQ effects for guitar. When shipped, the DataBase sorting option is set to "Sort by number", allowing you to use the knob to scroll through all of the 250 programs in numerical order in Program mode. (The < and > buttons will jump you forward and back ten programs at a time. Simultaneously pressing < and > jumps from 1 to 201 or from 201 to 1.)

You can select other sorting criteria in Program mode by pressing **Options**. The **Options** LED will blink and the display will show:

**Sort programs
by number**

Use the knob or the < and > buttons to select any of the main sorting options listed below:

- name
- number
- source type
 - (Acoustic, Drums, Guitar, Keyboard
 - Live PA, Tempo, Sound FX, Vocal)
- effect type
 - (Pitch, Chorus, EQ, Mod, Delay, Reverb:
 - Plate, Hall, Inverse, Gate, Dual)
- source & effect type
 - (any combination of source and effect types)
- members of MIDI maps
- members of pgm chains
- last 10 programs loaded

Press **Options** again to return to Program mode with the database sorted to show only those programs that fit the criteria you've selected. If you select "name", the knob will scroll you through all 250 programs in alphabetical order (The < and > buttons will jump you forward and back through letters of the alphabet.)

If you select any sorting option other than sort by name or number, the displayed selection of programs will be limited to those which fit the category. — We've made sure that all 200 of the preset programs are tagged for a variety of appropriate sorting options, so you'll find plenty to play with in the source, effect, and the source&effect categories.

When you select source or effect type as an option and return to Program mode, the knob will scroll through the programs in the first of the categories listed in parenthesis above. The < and > buttons will jump to the next sorting category.

When you select source&effect and return to Program mode, the < button will select source types, the > button will select effect types, and the knob will scroll through any programs which fit into the two categories selected.

Assigning source and effect types to programs is done in a database menu in Edit Mode.

Once you've made changes to a program, such as turning an effect off, or modifying any of the soft row parameters, an edit indicator (•) will appear in front of the program name. This identifies the program as having been altered since the last store procedure. This edit indicator, along with all of your changes, will disappear when you load another program.

To save your changes, press **Store**. The LED in the **Store** button will flash to let you know you are in the middle of a store procedure and the display will show:

Program Name
201 available

The upper line of the display shows the name of the currently running program. The lower line shows a user program number (201-250) and the name of the program currently stored there. (When the MPX 1 is shipped, the user programs are all "available".)

The < and > buttons move an underbar cursor in the display from the program number to each letter of the current name. Turning the knob will select another program number, or will select alphanumeric characters when the cursor is in the upper line of the display.

Once you've made changes to the program name or selected a new location for it, press **Store** again. The display will show:

Are you sure?
Yes or No

The numeric display will flash the user program number you have selected while you decide to press > **Yes** or < **No**. Once you have stored your program, it will automatically be added to the database and you will return to Program Load mode.

NOTE: If the stored program no longer meets the DataBase sorting criteria of the original version, the MPX 1 will automatically switch the DataBase setting to "Sort by number".

Program Store

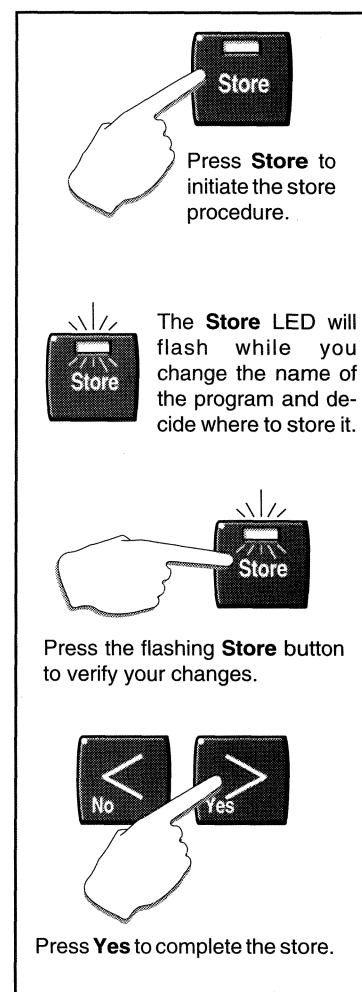

MPX 1 Preset Summary

#	Name	Effects					
		P	C	E	M	D	R
1	MPX Blue	■	■	■	■	■	■
2	RvbEko Morph			■	■	■	■
3	480PrimeFling	■					
4	RandomDetune	■					
5	Vintage Trem				■		■
6	Tap Delay					■	
7	Tape Echo					■	
8	ParametricEQ			■			
9	Chorus Chambr		■				■
10	Autowah Chrs		■	■			
11	Dialog			■			■
12	Small Booth			■			■
13	PCM 60 Room			■			■
14	Tiled Room			■		■	■
15	Bright Room			■			■
16	Plate Space			■			■
17	Ambience4 PA			■	■		■
18	Short Nonlin			■			■
19	Multigate	■				■	■
20	Gate 4 PA			■	■		■
21	Plate 4 PA			■	■		■
22	Bright Plate			■			■
23	Sweet+Wet			■			■
24	Vocal Plate			■			■
25	Snare Plate			■		■	■
26	BigDrumPlate			■			■
27	DrumgateFling		■				■
28	Drum Booth			■			■
29	Big Bottom	■					■
30	Percus Place						■
31	Snare Gate	■		■			■
32	Md Drumroom			■			■
33	Miked Room			■			■
34	Live Room			■			■
35	Empty Club			■			■
36	Big Studio			■			■
37	Garage			■			■
38	Chamber&Refl			■		■	■
39	Chamber 101			■			■
40	Jazz Chamber			■			■
41	Nice Chamber			■			■
42	Chamber Pan	■			■		■
43	Big Chamber			■			■
44	Chamber 4 PA			■	■		■
45	Hall 4 PA			■	■		■
46	Small Hall			■			■
47	Medium Hall			■			■
48	Large Hall			■			■
49	Piano Hall			■			■
50	Rich Hall			■			■

#	Name	Effects					
		P	C	E	M	D	R
51	Concert Hall			■		■	■
52	Tajma Hall			■			■
53	Small Church			■			■
54	Cathedral			■		■	■
55	M Sq. Garden			■			■
56	Morph Spaces					■	■
57	Process Verb		■	■	■		■
58	Ducker Verb		■				■
59	Reverse Rvb						■
60	Wavewash		■	■			■
61	Ghost Flange		■				■
62	Phased Space		■			■	■
63	Mod Space	■			■		■
64	DoubleEQ Rvb	■		■			■
65	Rev Wahtouch	■		■			■
66	Tap GatedRvb				■		■
67	TapDly/Rvb					■	■
68	Diffuse Dlys					■	■
69	IPS Tape Slap				■	■	■
70	Frame Delay					■	■
71	DlyFlangePan		■		■	■	■
72	ChaseEkoPan	■			■	■	■
73	Delay>Detune	■				■	■
74	Ducked Delay				■	■	■
75	Spin + Dlys				■	■	■
76	Ping Pong			■	■	■	■
77	Swept Echoes			■	■	■	■
78	EkoSweepFltr			■		■	■
79	Rockabilly					■	■
80	Guitar Solo	■			■	■	■
81	Sax Solo	■		■	■	■	■
82	Sidestik/Snr			■			■
83	MIDI Dot 8th					■	■
84	MIDI 1/4Note					■	■
85	AeroFreezeAB		■				■
86	Wide Chorus		■				■
87	RandomChorus		■				■
88	Chorus Hall		■				■
89	ChrsRvbMorph		■				■
90	Another Brick	■		■	■	■	■
91	Rich ChrsEko		■			■	■
92	Dynamic Chrs		■			■	■
93	Rubberate		■			■	■
94	FlangeNonlin		■	■			■
95	TalkinFlange		■	■			■
96	Tape Flange		■		■		■
97	CircleFlange		■	■			■
98	Slow Flange		■				■
99	FlangSweepAB		■			■	■
100	EP Tremolo	■			■	■	■

P=Pitch

C=Chorus

E=EQ

M=Mod

D=Delay

R=Reverb

#	Name	Effects					
		P	C	E	M	D	R
101	Phat Detune	■				■	
102	Detune&Dlys	■					
103	Detune+Hall	■					■
104	Pitch-O-Latr	■			■		■
105	S/H Pitch	■				■	■
106	Uni to Chord	■			■		■
107	Doubler	■				■	■
108	Wet Triads	■					■
109	Up 3 Down 5	■			■		■
110	4 Funky Comp	■	■				■
111	5th Plate	■					■
112	7th Octaverb	■			■		■
113	Oct Cascade	■				■	■
114	Power Chords	■			■		■
115	EkoVerbSweep		■				■
116	Telephone			■	■		
117	TV in Room			■	■		■
118	Car Radio			■	■		■
119	Capture EQ			■		■	
120	Miked Cab EQ			■			■
121	Vocal EQ			■			
122	GuitarCab EQ			■			
123	Tone 4 Gtr			■			
124	Phased Place	■	■				■
125	Fazer->DlyPan		■		■	■	■
126	FazerEkoRvb		■			■	■
127	FazerTremolo		■	■	■		■
128	PhaserOnStun		■				■
129	DbIPhaseGate	■	■				■
130	WahFazerPdl		■	■			■
131	Wah Delays		■	■		■	■
132	Wah Pan Dly		■	■		■	■
133	Wah Ped+Dist						
134	Echo-Wah	■		■	■	■	
135	Res A/Bsweep			■		■	■
136	Filter Thing	■		■	■		■
137	BigGtrChords	■				■	■
138	Rock Organ	■		■	■		■
139	OD Rotary		■	■	■		■
140	Rotary Cab		■				■
141	SynthChamber		■	■			■
142	Touch Spinner	■	■				
143	Random Pan				■		
144	StereoSpin	■		■	■	■	■
145	L=Dly R=Chmb					■	■
146	L=Dly R=Ambi					■	■
147	L=Dly R=Dtun					■	■
148	L=Ptch R=Chmb	■					■
149	L=Dly R=Ptch	■				■	■
150	L=2BndR=Chmb			■			■

#	Name	Effects					
		P	C	E	M	D	R
151	Dual 2-Band			■			■
152	Dual TapDlys					■	■
153	Ghost Mist		■			■	■
154	Submarine		■				■
155	50's Sci Fi	■				■	■
156	Synthis- izer		■	■			■
157	S/H Improv	■				■	■
158	MIDI Arp 1		■		■	■	■
159	MIDI 16thArp		■	■			■
160	A/B Freeze		■			■	
161	VolumePedal	■		■	■	■	■
162	Open the Door			■	■	■	■
163	No Traction	■			■		■
164	Call Waiting		■				
165	ClassicDtune	■					
166	Major/Minor	■					
167	Transposer	■					
168	Stereo Shift	■					
169	MIDIfixVocal	■					
170	Tuning Note	■					
171	Rich Chorus		■				
172	Rotary		■				
173	Aerosol		■				
174	Phaser		■				
175	Flanger		■				
176	Comb		■				
177	Stereo 2Band			■			
178	DigitalEQ(S)			■			
179	DigitalEQ(M)			■			
180	Crossover			■			
181	Wah Pedal			■			
182	Pedal Filter			■			
183	3-Tone			■			
184	LFO Filter			■			
185	RumbleFilter			■			
186	DynaTremolo				■		
187	Auto Pan BPM				■		
188	Broken Speakr				■		
189	Short Delay					■	
190	Double Delay					■	
191	[n]Eko Beat					■	
192	ShuffleDly					■	
193	Dual Echoes					■	
194	Wild Thing					■	
195	Small Foley						■
196	Small Room						■
197	Drum Gate						■
198	Small Gym						■
199	Tight Plate						■
200	Clean Slate						

P=Pitch

C=Chorus

E=EQ

M=Mod

D=Delay

R=Reverb

This chapter describes all of the MPX 1 edit functions. As the first thing you are likely to want to modify in a program are its effects, this section starts there and then moves on to all of the functions available in Edit mode.

Note that, in Edit mode, as elsewhere, the **Value** button acts as a toggle to allow you to assign "select" and "adjust" functions to either the knob or the < and > buttons, whichever is most convenient. As the default state of the **Value** button is On (lit) in Edit mode, any step by step instructions given in this section will assume this state.

Editing

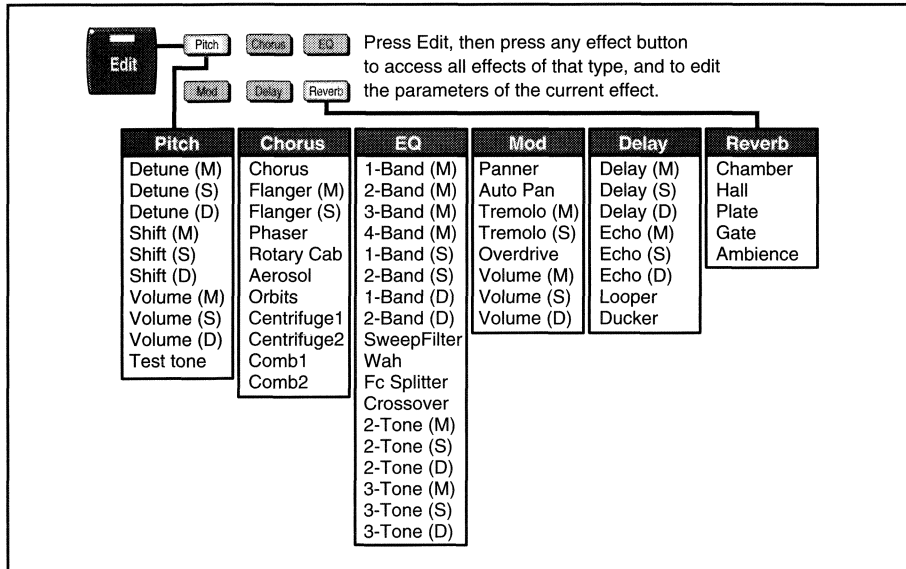
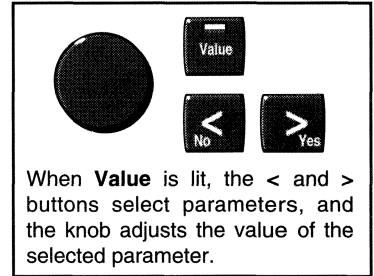

Effect Editing

To edit any effect, press **Edit**, then press an Effect button to view all of the Effects of that type, and to edit the parameters of the current Effect. The display will show the Effect type and the name of the currently loaded Effect. Turn the knob to view other Effects of the displayed type.

If you load a new Effect, an edit indicator will be displayed to show that the current program has been modified.

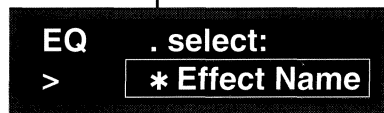

The Effect name will be marked with an asterisk (*) and the Effect button light will blink rapidly if the displayed effect can be loaded in the current program. (Press and hold the Effect button to display the name of the Effect currently in use.)

To load any available Effect, press the Effect button again. The asterisk will disappear from the displayed name and the button light will return to its normal slow blinking edit state. An edit indicator is displayed to indicate that the active program has been modified.

To edit the parameters of the current effect, press > . The display will show one or more parameters as shown below.

Coarse and Fine Editing of ms and Hz values

Parameters whose values are displayed in ms or Hz have overall ranges of more than 1000 units. When you select one of these parameters for editing, you'll notice that either the left or right portions of the value can be selected for editing. For quick, coarse adjustments, select the left portion of the value. For fine adjustments, select the right portion of the value. The fine and coarse increments for each type of parameter are:

ms (delay times)

coarse increments=100 ms
fine increments=1ms

Hz (LFO rates)

coarse increments=1 Hz
fine increments=.01Hz

Hz (EQ Fc)

coarse increments=100 Hz
fine increments=1Hz

One or two parameters will be shown on each parameter screen. An edit indicator appears in front of the parameter name if the value has been changed since the last store operation.

The Effect type is shown in the upper left of the display.



Parameter values are shown on the bottom line of the display.

Fields which are selected for changing will blink.

The item on the lower line of the display which is selected for adjustment will flash. Turn the knob to scroll through the entire range of parameter values. Use the < and > buttons to select another parameter value field and to move to another parameter screen.

Detailed information on each Effect and its parameters is provided in Chapter 7.

Press **Edit** to return to the main Edit menu.

The MPX 1 Edit Menu

The MPX 1 Edit Menu give you access to all of the controls you need to create your own programs. Whether you want to reassign the front panel meter display, re-route the effects in a program, or create an entirely new sound, you will find the tools you need in this section.

The complete Edit mode menu structure is shown below, followed by detailed explanations of each main menu selection.

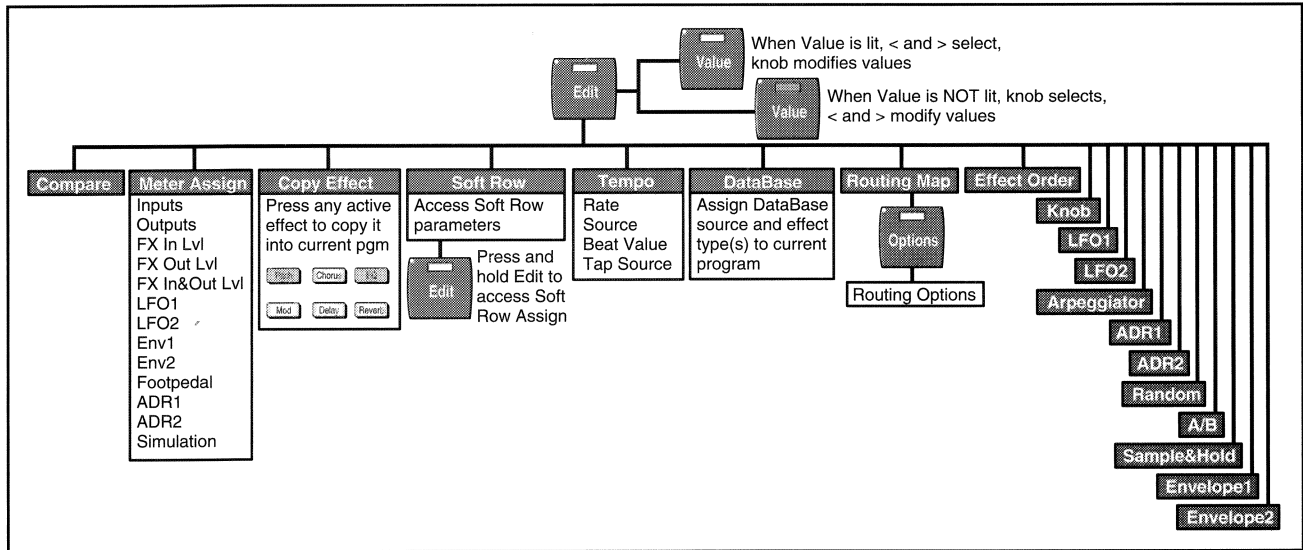

Press **Edit** to enter the main **Edit** menu, and use the knob to select the particular submenu you want (**Compare**, **Meter Assign**, etc.). Use the < and > buttons to enter the submenu and select parameters, and the knob to adjust parameter values. Press **Edit** again to return to the main **Edit** menu.

Whenever you edit an MPX 1 program, an edit indicator will appear in Program mode, in front of the program name on the display to let you know that the program has been changed since the last store operation.

Compare

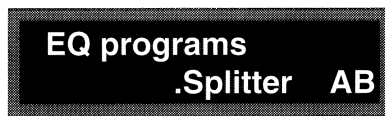

In Program mode an edit indicator appears before the program name if the program has been changed since the last store operation.

To hear the original version, press **Edit** to show the **Edit select** screen. Turn the knob to display **Compare**.



Edit select:
> **Compare**

Press the > button. If the program has not been edited, the message **Pgm is unchanged** will be displayed. If the program has been edited, the display will change to show:



Compare:
Edited Original

Use the < and > buttons to select and hear your edited version, or the original. To exit, press **Edit** to return to the main **Edit** menu.

NOTE: If you exit with **Original** selected, you can view the original program parameters, but cannot edit them. To continue editing, exit with **Edited** selected.

Meter Assign

When shipped, the headroom display on the MPX 1 front panel is set to display Input Level. In the Meter Assign menu, you can change the assignment for the current program to have the display meters show any of the following:

- Inputs
- Outputs
- Effect Input Level
- Effect Output Level
- Effect Input and Output Level
- LFO 1&2
- Envelopes 1&2
- Footpedal
- ADR 1&2
- Simulation

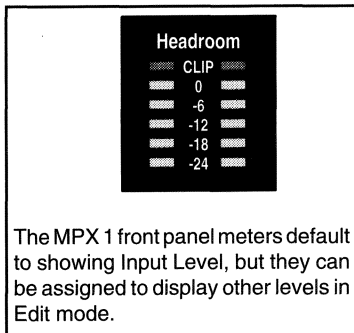

The selection that you make here will take effect immediately and will be stored with the program. Press **Edit** to exit to the main **Edit** menu.

Copy Effect lets you take an Effect from any program in the MPX 1 and copy it into the current program. To use this function, select **Copy Effect** from the Edit menu. Press the > button and use the knob to display any of the MPX 1 programs. The front panel Effect buttons light to show you which effect blocks are active in the displayed program. Press any lit button to display:

The name of the effect from the displayed program appears on the upper line.

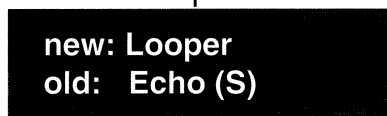

The name of the effect you will be replacing in the current program appears on the lower line.

The effect button will flash to show that it is selected for copying. Press it to copy the effect you selected into the current program. If the copy procedure is successful, a confirmation message will be displayed briefly, and the display will revert to showing the Copy Effect selections.

As different effects vary widely in the amount of processing they require, not all combinations of effects are possible. If the current program is already using many effects, or if it is using a combination which requires maximum processing power, a message will be displayed informing you that there are not enough resources to run the effect you have selected. If this happens, you can try copying another effect, or you can copy an inactive effect (by pressing an unlit button running "No Effect") to reduce the processing requirements.

Note that patches are not copied along with effects.

Press **Edit** to exit to the main **Edit** menu.

Copy Effect

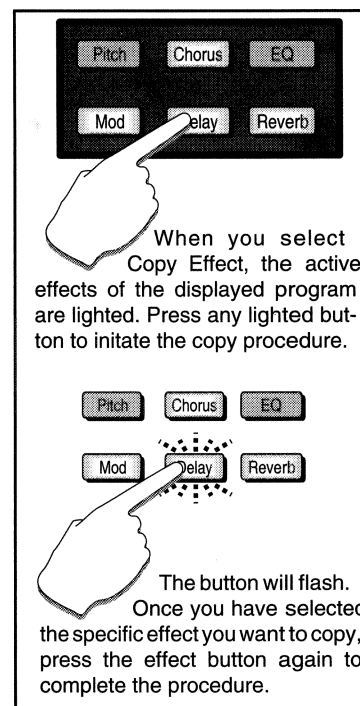

Soft Row Parameter Assignment

Parameters that you want to assign to the Program mode Soft Row for easy access are selected from the Edit mode **Soft Row** menu. When you first select **Soft Row** in Edit mode, you have direct access to all of the Soft Row parameters, exactly as in Program mode. You can scroll through these and alter values with the knob and < and > buttons.

To change the Soft Row assignments, press and hold **Edit** with any Soft Row parameter displayed. Continue to hold the button down until the message: **Entering Soft Row Assign** is displayed. The **Edit** LED will blink, and the first Soft Row parameter will appear on the display as shown:



```

Edit  Soft 1:
>  EQ Mix
  
```

Use the knob to scroll through the entire list of parameters for the current program. Use the < and > buttons to select any of the ten Soft Row positions. With the parameter and position you want assigned to the Soft Row displayed, press **Edit**. The display will return to the Soft Row, with the new parameters in the positions you have selected. Turn the knob to move across the Soft Row and the < and > buttons to adjust the parameter values. Press **Edit** to return to the main **Edit** menu. When you return to Program mode, your new Soft Row will be in place.

Tempo The parameters in the **Tempo** menu: Rate, Source, Beat Value, Tap Average, Tap Source and Source Level, allow you to select the way in which the actual tempo in BPM is determined for each effect.

The MPX 1 gives you unique control over tempo. In the MPX 1, any delay parameter and any time-based modulator (LFO, etc.) can be individually assigned to an absolute time value, or assigned to a tempo value.

For example, a delay time can be set to a specific number of milliseconds, and you will always get a delay of that number of milliseconds, regardless of tempo changes. Alternatively, a delay time can be set to a specific ratio of echoes to beats. Now, if you create a rhythmic echo pattern, delay times will be linked to tempo. When you change tempo, the delay time will change to maintain the same rhythm at the new tempo.

With the LFOs, the rate of change can be an absolute value (such as once per second), or it can be linked to tempo (for example, once every four beats). Any delay parameter or LFO rate can be set to its own individual rhythm, allowing you to set up an effect which will change in a rhythmically interesting way — evolving over time, for example, as opposed to being a mere series of repetitions. Once delays and LFO rates are assigned, tempo rate can be easily changed in a variety of useful ways.

Tempo **Rate** can be set internally or via MIDI Clock. If Tempo **Source** is set to **Internal**, you can dial in any tempo from 41-400 BPM, or you can press the front panel **Tap** button twice in rhythm to establish the rate you want (allowing you to change tempo on the fly from any mode). You can also have the value of a patch source act as a tap trigger (See Chapter 4: *Patching*.) or choose to have your tempo transmitted as a MIDI Clock signal to control the tempo of connected MIDI devices. (See Chapter 5: *System Controls* or Chapter 6: *MIDI Operation*.) If **Source** is set to **MIDI Clock**, MPX 1 tempo will sync to incoming MIDI Clock. Whether tempo is set internally or via MIDI, the front panel **Tempo LED** will flash at the current rate whenever any delay or LFO rate is set for tempo control.

MPX 1 programs can have their own tempo rate settings which are stored with the program. (Check out those tagged for DataBase sorting by "Tempo" for some examples.) You can override these individual tempo rates with a global tempo rate in the System Setup menu. Tempo is also available as an independent patch source which can control any program parameter. (See Chapter 4: *Patching* and Chapter 5: *System Controls*.)

This is the current tempo (in beats per minute). When **Source** is set to **Internal**, you can select any rate here from 41 to 400 BPM. The **Tempo LED** will flash at the new rate. Fractional tempos can be tapped in, but the display will always show the nearest whole number value.

You can choose to have tempo determined by the MPX 1 **Tap** and **Rate** controls (**Internal**), or by MIDI Clock (**MIDI**). **Tap** also acts as a reset, setting the downbeat of the LFOs.

Tempo is expressed in BPM. This control allows you to specify the value of the beat (Eighth, DottedEighth, Quarter, DottedQuarter, Half, DottedHalf, Whole). If, for example, the rate is 120 BPM, and you select **EighthNote** here, the tempo will be 120 eighth-notes per minute. If you select **QuarterNote** here, the tempo will be 120 quarter-notes per minute. (The factory default is **QuarterNote**.)

Option: Tap Average

Press **Options** to access the **Tap Average** control which allows you to average the last 2-8 Taps. Higher numbers mean that the response to incoming Taps will be more gradual, as the tempo will be updated on each Tap with an averaged value.

Assign the **Tap** function to any of the MPX 1 Internal, MIDI or MIDI controllers (None, On, Knob, Puls1, Tri1, Sine1, Cos1, Puls2, Tri2, Sine2, Cos2, Rand, Arp, ADR1, ADR2, S/H, Env1, Env2, Mtr1, Mtr2, A/B, ATrg, BTrg, ABTrg, Pedal, Tog1, Tog2, Tog3, Sw1, Sw2, Sw3, CC1-31, CC32-119, Bend, Touch, Vel, Last Note, Low Note, High Note, Tempo, Cmnds, Gate, Trig, LGate, TSw).

Option: Tap Source Level

Press **Options** to access the **Tap Source Level** control which allows you to set the level (0-127) at which the Tap function is triggered.

Rate

Source

Beat Value

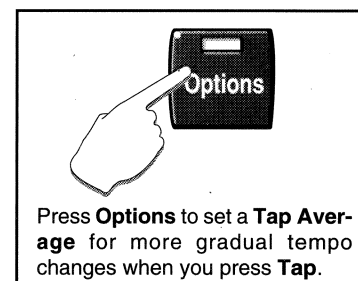

Tap Source

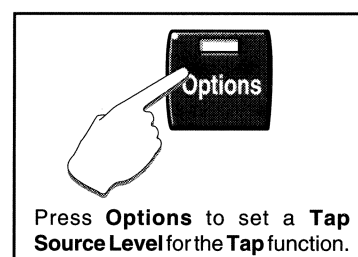

DataBase — Assigning DataBase Source and Effect types to the current program

The MPX 1 allows you to individually tag all 250 programs for easy sorting by Source and/or Effect type. The **DataBase** controls in the **Edit** menu let you assign your programs to any (or all) of the categories shown below.

Source type: Acoustic
Drum
Guitar
Keyboard
Live PA
Tempo
Sound FX
Vocal

Effect type: Pitch
Chorus
EQ
Mod
Delay
Ambient
Chamber
Plate
Hall
Inverse
Gate
Dual

When you select **DataBase**, the display will show selection like the one below.

The upper line identifies the selection as a Source or Effect type.

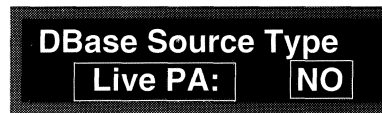

The lower line shows the Source or Effect type and the current DataBase selection (YES or NO). The selected field will flash to let you know which is selected for changing.

The item on the lower line of the display which is selected for adjustment will flash. Use the < and > buttons to move between the display fields. Use the knob to scroll through all of the Source and Effect types in the left field, and to select **YES** or **NO** in the right field.

If you make changes in the **DataBase** menu, when you exit, the **Store** LED will flash and the following message will be displayed.



Press **Store** to save your changes to the DataBase. Press any other button to exit with the DataBase unchanged.

Press **Edit** to return to the main **Edit** menu.

Routing Map

The MPX 1 allows you to reconfigure the effect blocks along audio paths of your own design. The Routing Map is a graphic display that shows routing and connections between the MPX 1 effect blocks. Use the Routing Map to change connections between individual effects and also to change the overall routing configuration of all six effect blocks as a group. All of the routing controls available in the Routing Map menu are explained in this section, along with examples of the selections you can make. Remember that you can change the *order* of the effect blocks as well. This is covered in the next section *Effect Ordering*. In these examples, we'll use the default effect order to keep things simple.

The MPX 1 supports two independent stereo paths for signal routing between blocks. The input path can be split into two, and once split, the two paths can be merged together again. These two paths are referred to as **Upper** and **Lower**.

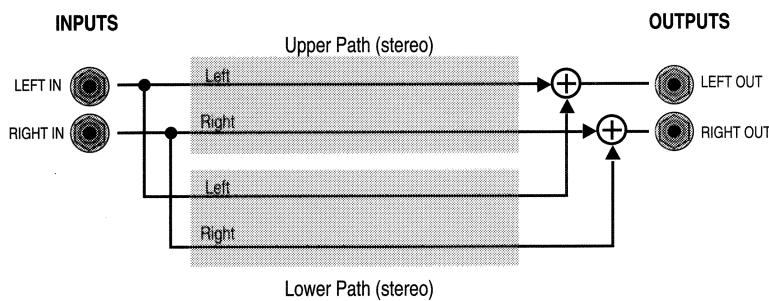

The audio path through a generic MPX 1 Effect block looks like this:

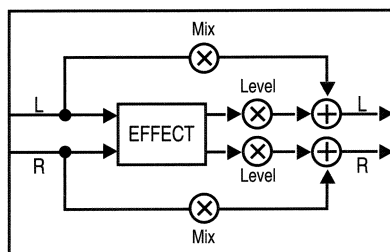

Note that the dry path through the block is stereo. The wet path through the block can be stereo or mono in, and stereo or mono out, depending on the particular effect.

Each of the Effect blocks (Pitch, Chorus, EQ, Mod, Delay and Reverb) is represented in the following discussion as a simple box identified by its first initial (P, C, E, M, D and R). This is also the way each block is represented in the MPX 1 Routing Map display. MPX 1 inputs and outputs are represented by the letters I and O.

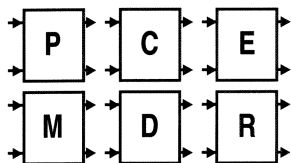

Active Effects are represented (here and in the Routing Map) by upper case letters.

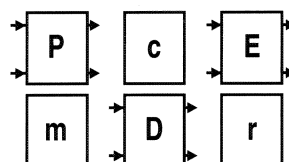

Inactive Effects are represented (here and in the Routing Map) by lower case letters.

How to Change Routing Connections

The routing page lets you alter the connections between the inputs of the selected block and the outputs of the blocks in front of it. It is easy to think of these connections as patch cords connecting the different blocks. There are five possible connections for the inputs of any block.

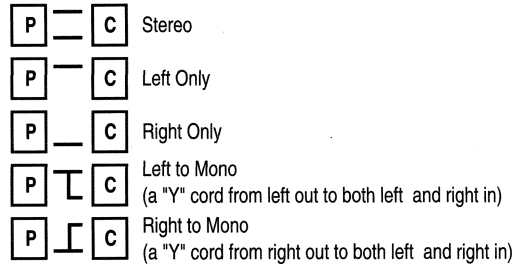

On the Routing Map, use the < and > buttons to select any upper case letter. (Lower case letters indicate inactive effects, which cannot be edited.) Use the knob to set your connection choice.

How to Change Routing Options

The **Routing Map** options allow the six Effect blocks to be placed in any configuration on one (upper) or both (upper and lower) paths. The following examples shows the six effects on a variety of path configurations. (Connections between all blocks are shown as stereo.)

Press **Options** to determine the routing configurations for all blocks. Press **Options** again to return to the Routing Map.

All six effects are on the upper path.



The six effects are configured on both upper and lower paths.

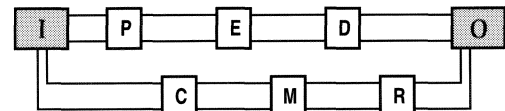

The path is split at the input, merged at the EQ effect, split again at the Mod outputs and merged at the output.

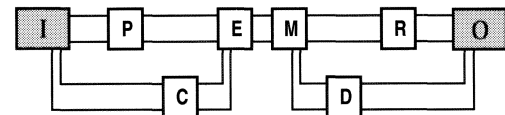

The path is split at the Pitch outputs, merged at the EQ inputs, split again at the Reverb inputs.

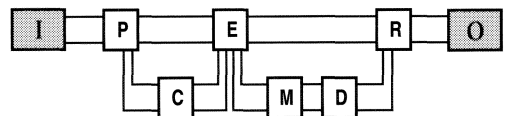

To change the routing, from the **Routing Map**, press **Options**. Use the < and > buttons to select individual blocks. Use the knob to change the configuration.

Note that the MPX 1 will only display the routing options that are available in the current configuration. For example, if all six blocks are on the upper path, the only available option will be **Split**. The next block downstream from a Split will have **Upper**, **Lower**, and **Merge** available as options, and blocks further downstream will have **Parallel** as an option as well.

In the following example we've selected one of the presets, **FazerTremolo**, as an illustration of the kind of programs that can be created with the MPX 1 routing and connection capabilities. **Routing Example**

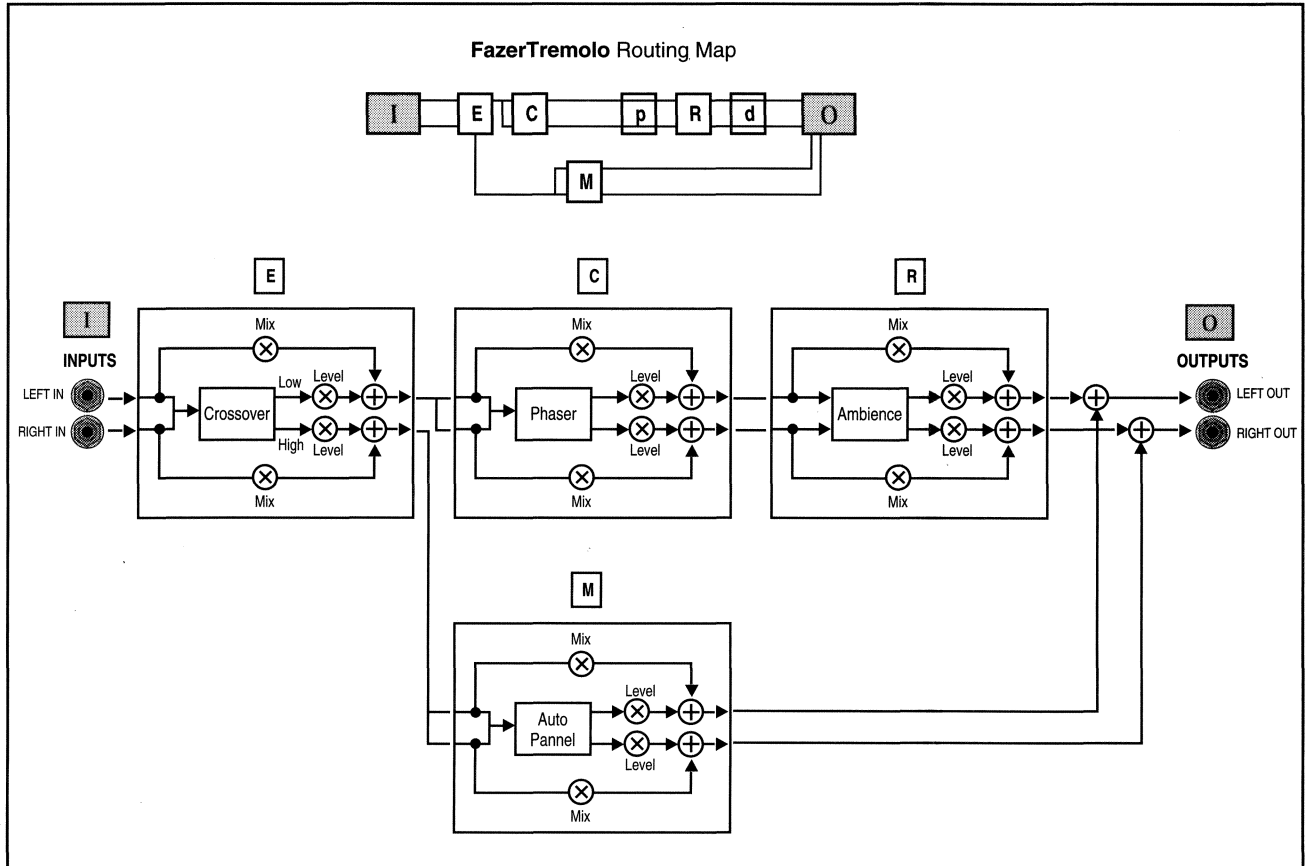

In this program, the input signal is routed into an EQ block (Crossover) where it is summed to mono. The low frequencies are sent out the left, and the high frequencies out the right. The EQ block option is set to Split, creating two parallel audio paths. The Chorus block (Phaser) is on the upper path, the Mod block (AutoPanner) is on the lower path.

The Chorus inputs are connected to the left output of the EQ block. The inputs of the Mod block are connected to the right output of the EQ block. The Chorus outputs are connected to the Reverb block.

The Reverb and Mod block outputs are merged at the MPX 1 outputs. Inactive effects (Pitch and Delay) are not shown.

This creates a program that phase shifts the low frequencies and auto pans the high frequencies. Ambience is applied only to the low frequencies. (This preset is great for clean guitars, bass and keys.)

Notes and Tips on Routing

1. The number of configurations you can create is huge. The best approach to take is to think about what you want before changing anything.
2. When changing the routing options, work from left to right — from the input block to the output block.
3. The MPX 1 will only display the routing options that are available in the current configuration. For example, if all six blocks are on the upper path, the only available option will be **Split**. The next block downstream from a Split will have **Upper**, **Lower**, and **Merge** available as options, and blocks further downstream will have **Parallel** as an option as well.
4. The MPX 1 automatically updates the routing options downstream from the selected block as necessary. For example, if you change a **Split** path to **Upper**, all of the following blocks will be set to **Upper** as well.

Selecting **Effect Order** from the Edit menu allows you to put the six MPX 1 Effect blocks in any order you wish. Press > to display the current ordering and routing configuration. An ordering display such as the one shown below will appear.

Effect Order

An underscore identifies the Effect block which is selected for moving to a new location.

Ord p=Ce=m=D=R

Effect types are represented by their initial letters. Upper case letters indicate that the Effect is active in the current program. Lower case letter indicate that the Effect is inactive.

Each Effect block is represented by a single letter, upper case if the Effect is active in the current program, lower case if it is not. The symbols between each letter indicate the current routing connection options. An underscore identifies the Effect block that is currently selected for repositioning. (In the example shown above, the Chorus block is selected.) To move the selected block to a new position, simply turn the knob. Use the < and > buttons to select (underscore) a different Effect block for repositioning.

Using the same example, turn the knob two clicks to the right to move the Chorus block and alter the Effect Order as shown below.

The Chorus block is selected for repositioning.

Ord p=Ce=m=D=R

Turn the knob one click to the right to swap the Chorus block with the EQ block.

Ord p=e=Cm=D=R

Turn the knob one more click to the right to move the Chorus block another step to the right.

Ord p=e=m=CD=R

Press **Edit** to return to the main **Edit** menu.

Setting the Parameters of the Internal Controllers (Knob, LFO 1 and 2, Arpeggiator, ADSR 1 and 2, Random, A/B, Sample & Hold, Env 1 and 2)

The last of the MPX 1 Edit menu selections provide controls for making individual adjustments and assignments for each of the MPX 1 internal controllers. This section describes controller editing. For detailed information on the controllers themselves, see Chapter 8.

Making controller adjustments is straightforward. Press **Edit** and select the controller you want to adjust. The first of the controller selections (**Knob**) is shown here as an example. (Although each controller has a different set of parameters, the method for selecting and adjusting them is identical.)

Use the < and > buttons to step through the available parameters of the selected controller and the knob to adjust controller settings.

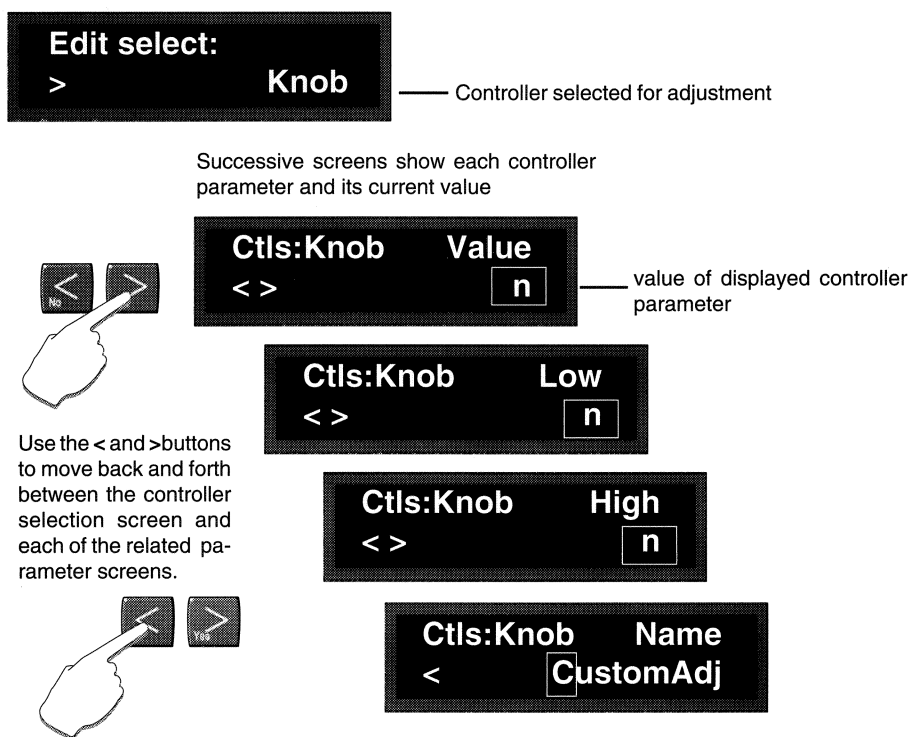

Once you have adjusted the selected controller to your satisfaction, you can step back through the parameter screens, or press **Edit** to return to the main Edit menu.

To exit Edit mode, press **Program** or **System** to select another mode of operation.

Patching

Patching is the ability to assign a control (Source) to a parameter (Destination). This allows you to alter the value of the parameter by manipulating the control Source. For example, you can select the front panel knob as a Source and an effect's Mix parameter as a Destination. This simple patch will allow you to dynamically alter the mix of the effect whenever you turn the knob. You can create as many as five patches. You can patch multiple parameters to a single controller, or patch multiple Sources to a single Destination. This chapter contains all the information you need to use the MPX 1 patching system. Global Patching is described in Chapter 5: *System Controls*.

Note that, in the Patching System, as elsewhere, the **Value** button acts as a toggle to allow you to assign "select" and "adjust" functions to either the knob or the < and > buttons, whichever is most convenient. As the default state of the **Value** button is On (lit), any step by step instructions given in this section will assume this state.

MPX 1 Patch controls are brought right out to the front panel for easy access. From any mode of operation, just press **Patch** to access these controls.

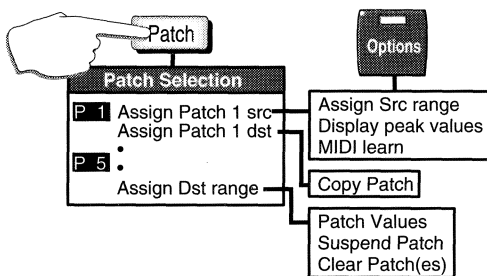
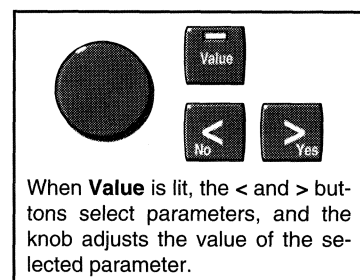

From anywhere, press **Patch** to immediately access any patch assigned to a displayed parameter, or to create or alter a patch.

The **Patch** button LED will flash to let you know **Patch** is active. The display will show:



The numeric display will show the Patch number you have selected, as long as the **Patch** button is active.

The Patch number you select in the alphanumeric display will be displayed on the large numeric display as well. This display will remain on as long as you are in the Patching System to identify the currently selected patch.

Patch Jump from Edit Mode

Whenever a patched parameter is selected for adjustment in **Edit** mode, the **Patch** LED will light to let you know that the parameter is being used in a patch. If you press **Patch**, you will "jump" directly to the patch that uses the displayed parameter so that you can view and modify the patch. Pressing **Patch** again will jump you back to the parameter in **Edit** mode.

Selecting a Source and Destination

From the patch number display, press > to step to the patch Source and Destination assignment screen. The display will show the current Source assignment on the top line, and the current Destination assignment on the bottom line. One of the assignments will be flashing to let you know which is selected for adjustment. Use the < and > buttons to select the Source assignment field, and the knob to select a Source from the available list.

Patch Sources

All Sources are the same in the sense that each generates an output value in the range of 0-127. The output value is used to increase or decrease the setting of a Destination parameter value. Some generate values continuously (they're always "on"); some generate output based on the position of a particular external MIDI controller, or a footpedal, or footswitch. Some Sources generate output based on aspects of physical performance such as how loud, how fast, or how hard you play. The MPX 1 allows you to choose a Source for each Destination from the following list.

Patch Sources		
Ctls: Off	MIDI: CC 1	
On	•	
Knob	•	
LFO1	Puls1	
	Tri1	CC31
	Sine1	CC33
	Cos1	•
LFO2	Puls2	•
	Tri2	•
	Sine2	CC119
	Cos2	Bend
Rand	Touch	
Arp	Vel	
ADR1-2	Last Note	
S/H	Low Note	
Env1-2	High Note	
Mtr1-2	Tempo	
A/B	Cmnds	
ATrg	Gate	
BTrg	Trig	
ABTrg	LGate	
Pedal	Tsw	
Tog 1-3		
Sw 1-3		

Sources are displayed with the prefix **Ctls** or **MIDI**. **Ctls** are internal MPX 1 controllers and rear panel switches and pedal inputs. **MIDI** sources are all designated MIDI controllers.

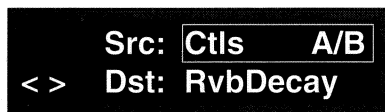

In this example, the Source assignment field is selected. The knob will scroll through all of the available Source selections.

From the same screen, use the < and > buttons to select the Destination assignment field, and the knob to select a Destination from the list of parameters of the currently loaded program.



With the Destination assignment field selected, the knob will scroll through all of the parameters of the currently loaded program.

For most applications, that's all there is to setting up a patch. The default patch values will set the controller to match the full range of its travel to the full range of the Destination parameter. To customize your patches, the MPX 1 provides a full set of additional controls. Each of these is described in the following sections.

With **Src** selected, pressing **Options** will allow you to specify range limits for the controller you have selected. With the following screen displayed, use the < and > buttons to select the **Min**, **Mid** or **Max** field, and the knob to set the value from 0-127. The default settings of Min=0 and Max=127, cause the parameter to be controlled linearly by the controller. Reversing these values (Min=127 and Max=0) will establish inverse control over the parameter. Adding a Mid value allows you to put a pivot point in the patch. All patches have default settings of Min=0, Max=127, with no Mid values assigned.



In this example, the underscore indicates that the Min value field is selected. The knob will select values from 0-127. Press > once to select the Mid field, once again to select the Max field.

Changing the Range of the Source Controller

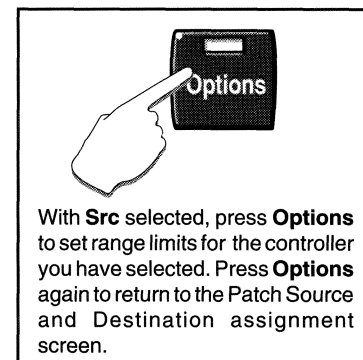

From the Src Value screen pressing the > button beyond the Max value field selects a reference screen where you can view the actual behavior of the controller you've selected.

Viewing Source Controller Activity

With the Max value field selected, pressing > will forward you to the Source Activity screen.

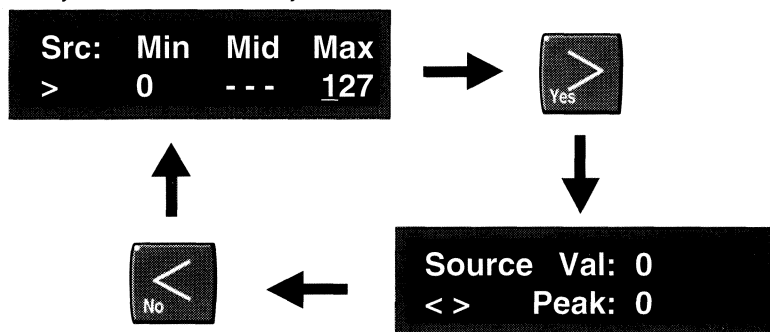

Press < to return to the Source Value screen.

The Source Activity screen lets you reference actual controller values to help you determine the most useful range.

The Source Activity screen displays the actual activity of the controller you have designated as the Patch Source. Moving the controller will allow you to view the actual controller value in real time (**Val**). The peak controller value is referenced on the lower line (**Peak**). This lets you quickly determine the most useful range settings for the controller.

For example, if you have selected Input Level as the Source, and you notice from the Activity screen that the actual level never rises above 100, you can quickly back up to the Src Value screen (press < once) and set the Max value to 100.

MIDI Learn — Automatic Controller Assignment

You can have the MPX 1 automatically recognize a MIDI controller as a patch Source, as well as assigning its MIDI Receive channel to match any controller with the **MIDI Learn** function.

From the Source Activity screen, press > to access the **MIDI Learn** screen. With this screen displayed, simply move any active MIDI controller to automatically assign it as the Source for the current patch. The MPX 1 will also recognize the MIDI channel of the controller and reset to that channel for receipt of all incoming MIDI messages.

From the Source Activity screen, press > to access **MIDI Learn**.

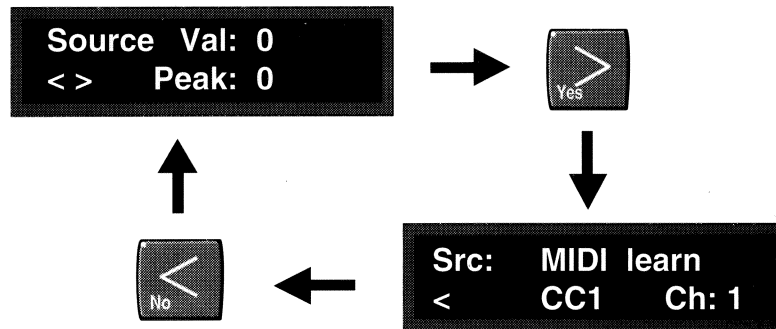

Press < to return to the Source Activity screen.

Simply move any attached MIDI controller to have the MPX 1 recognize it as the patch Source and switch to its MIDI channel. This example shows the result of moving a Mod Wheel (CC1) on a connected MIDI device transmitting on Channel 1.

From the **MIDI Learn** screen, press < repeatedly to step back through the Patch Source Options. Press **Options** to return to the Source and Destination assignment screen. Press **Patch** to exit the Patching system.

Copying Patches

From the Source and Destination assignment screen, selecting **Dst** and pressing **Options** will allow you to copy any other patch to the patch you are working on. With the following screen displayed, use the knob to select patch 1-5, or — to leave the current patch unchanged.

With **Dst** selected on the Source and Destination assignment screen, press **Options** to copy any other patch into the current patch. Your selection will take effect immediately when you exit by pressing **Options** again.



In this example, — indicates no patch information is to be copied. Other selections (1-5) will automatically copy information from the indicated patch to the current patch when you exit **Options**.

Changing the Range of the Destination Parameter

For most applications, the default full-range Destination values are all you will want, as these allow your selected Source to exert direct control over the full range of parameter values. In other cases, you may want to adjust the Destination values to a more limited range, or establish a nonlinear relationship between the controller and the parameter values.

With a Destination assigned, and the Destination field selected, press > to display the first of two Patch Value screens where you can set Min and Max limits for the selected parameter. With **Max** selected, press > again to display a Mid Point selection screen where you can set a pivot point within the Destination parameter range to allow nonlinear control.

Note that, once a Mid value is selected, it can only be eliminated by repatching the Destination, or by clearing the patch.

With the Destination assignment field selected, press > to display the Destination value screen.

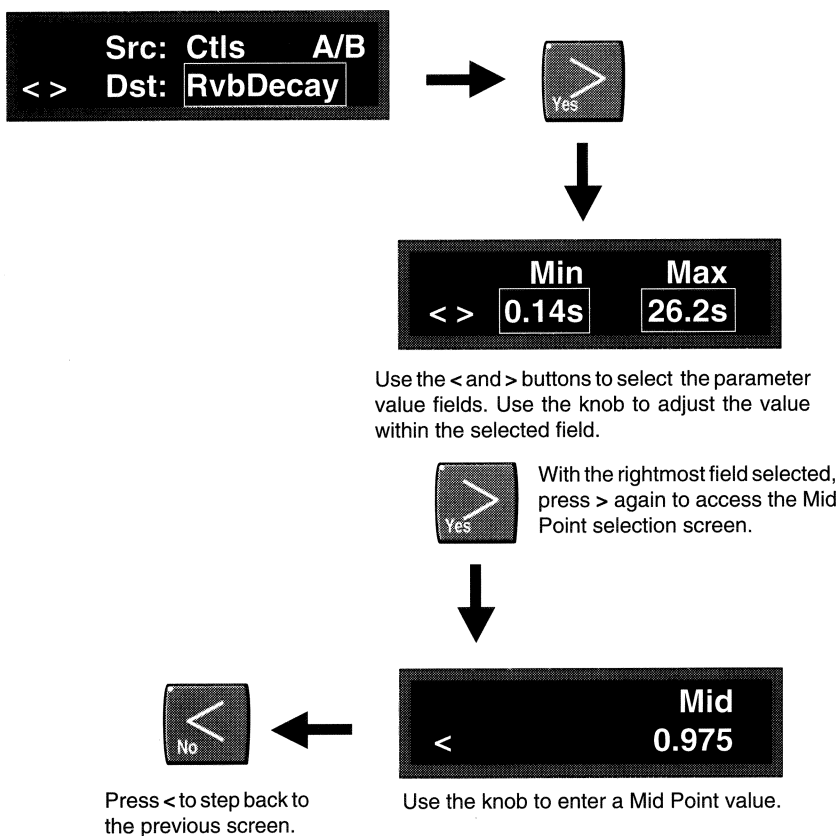

Linear or Nonlinear Control

From either of the Destination Values screens, pressing **Options** will allow you to set the control relationship between your Source and Destination, temporarily suspend the current patch, or to clear one or more patches entirely.

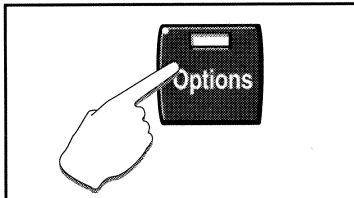

Pressing **Options** from either of the Destination value screens lets you determine the control relationship between the Source and Destination, and clear any or all patches. Your selection will take effect immediately when you press **Options** again.



"Unchanged" is provided as a selection to allow you to exit **Options** without altering or erasing any patches. Pressing > will step you forward through the other options.

As selections made in **Options** will take effect immediately when you press **Options** to exit, the first screen, "Unchanged", gives you the choice of exiting without altering or erasing any patches.

Press > to step through the other control selections: **Normal**, **Inverted**, **Mid Peak**, and **Mid Dip**. These let you set the control relationship between the controller and the parameter as described below.

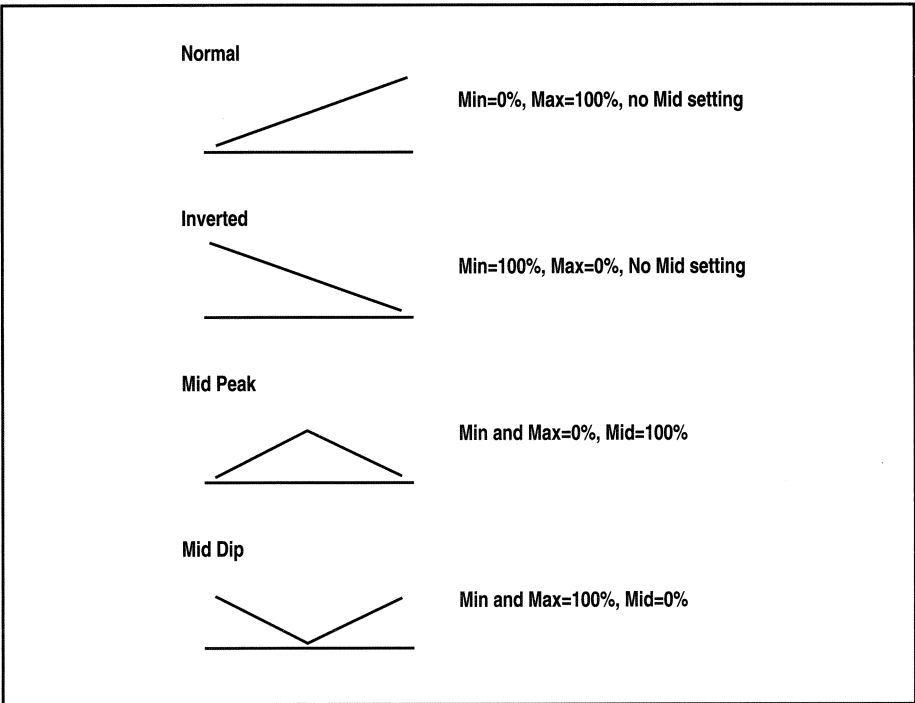

Continuing to press > will step you to the **Suspend** option. Selecting **Suspend** temporarily suspends the patch until such time as you return to the Patch System Destination Option and select **Unsuspend**.

Suspending and Clearing Patches

Continuing to press > will step you to the options: **Clear 1-5**, and **Clear All**. These allow you to select any or all patches to be cleared.

Once you have made any selection, press **Options** to have your choice take effect and to return to the Source and Destination Assignment screen.

If you create two or more patches with the same Destination, the Destination value will be the sum of all patches assigned to it.

Multiple Patches with the Same Destination

For example, if a Footpedal, and the knob are both assigned to Mstr Mix, the Mix value will be the sum of the patch Destination values for those two patches. When creating multiple patches to the same Destination, you should set the individual Destinations to values which, when added together, are less than or equal to the maximum value for each parameter. The Footpedal and the knob, for example, could each have a maximum value of 50%, or they could be assigned values of 25% and 75%, 60% and 40%, etc.

When the sum of multiple patched parameter Destination values is greater than the maximum value of the parameter, the parameter value will remain at maximum until the sum of the patches falls below it.

System Controls

The System menus shown below provide access to all of the controls which affect overall operation of the MPX 1, such as Bypass state, MIDI transmit and receive channels, as well as some unique options that make the MPX 1 adapt to your personal requirements. These controls are each explained in detail in this chapter, in the order in which they are displayed in System mode.

Note that, in **System** mode, as elsewhere, the **Value** button acts as a toggle to allow you to assign "select" and "adjust" functions to either the knob or the < and > buttons, whichever is most convenient. As the default state of the **Value** button is On (lit), any step by step instructions given in this section will assume this state.

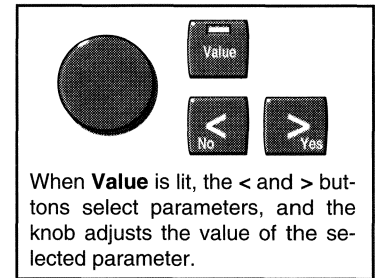

The System Menus

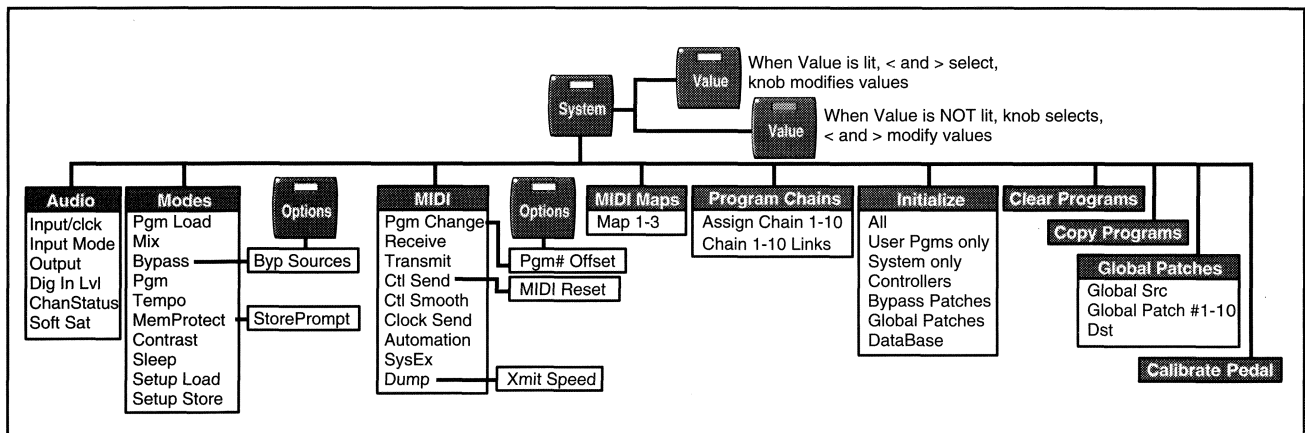

Press **System** to enter the **System** menu, and use the knob to select the particular menu you want. With the menu of your choice displayed (**Audio**, **Modes**, etc.), use the < and > buttons to enter the submenu and select parameters, and the knob to adjust parameter values. When you're finished making adjustments within any menu, press **System** to return to the main **System** menu, or press the < and > buttons to select another control from the same menu.

Audio Controls

The Audio menu allows you to change the settings of controls which affect the MPX 1 audio input and output characteristics. These include: configuring the inputs for stereo or mono applications, selecting analog or digital inputs and outputs, etc. The controls available are each described below.

Input/clock

The MPX 1 can use its own internal clock or it can reference an external clock. Depending on your rear panel connections, select **Analog/Int**, **Analog/Ext** or **Dig/Ext**. When **Analog/Ext** or **Dig/Ext** is first selected, the MPX 1 will repeatedly try to establish lock with an external digital source. If it is unable to establish lock, an error message will be displayed. Pressing any button will allow you to clear the error message and will return you to the Audio screen with **Analog/Int** selected. To select **Analog/Ext** you must connect a source of digital clock at the digital input. Note that the MPX 1 will accept only signals at 44.1kHz.

During operation, loss of lock will trigger an error message if repeated resync attempts fail. LEDs on the front panel numeric display inform you when digital signals are being received, and when lock is established.

Front panel indication of the presence of incoming digital signals, and lock success is presented at the top of the numeric display.

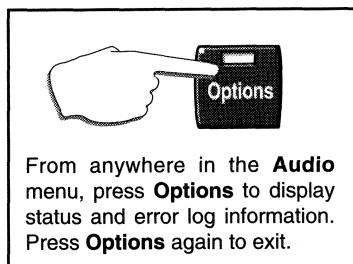
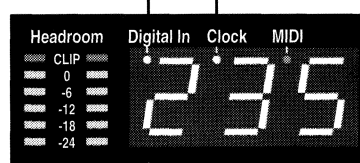

Options: Error Log and Status

Pressing **Options** gives you access to the following status and error log information:

Error Log:	Data: nnnn	4-digit parity error count
	Invalid: nnnnn	5-digit invalid data error count
Click Status:	Internal	indicates Analog/Int selected as input
	Locked	Analog/Ext or Dig/Ext selected as input and valid clock is present

Input Mode

The setting of **Input Mode** affects both analog and digital inputs. Select **Stereo** to have left and right inputs processed separately. Select **Mono (L only)**, or **Mono (R only)** to have only the left or only the right input processed. (The other input is ignored.)

Output Mode

In **Output Mode**, select **Analog** or **Digital** as the output mode of the MPX 1.

Dig In Lvl is a master control for digital inputs. Select **Off** or a value from -89dB to +6dB to optimize the level of the digital input signal.

Dig In Lvl

When digital input is connected to the MPX 1 and **Dig/Ext** is selected in the **Input/Click** menu, the **ChanStatus** menu allows you to determine whether or not Channel Status information received via the MPX 1 digital input is transmitted unchanged through the MPX 1 or whether the MPX 1 is to generate its own Channel Status data. The available selections are: **Pass thru** and **Generate CS**. (If **Analog/Int** or **Analog/Ext** is selected in the **Input/Click** menu, the display will show **Generate CS** without the option of another selection.)

ChanStatus

The **Soft Sat** control puts an analog soft-knee limiter in front of the input of the MPX 1 A/D converter. This control essentially allows you to trade the harshness of digital distortion for a softer, analog version. The harshness associated with A/D overload at signal levels above -3dBfs is reduced. Increased analog distortion will occur in the range of -3dBfs to 0dBfs. The available settings are **On** and **Off**.

Soft Sat

The MPX 1 **Modes** menu allows you to specify certain system-wide parameters and modes of operation for convenience. Each of these is described in this section.

Modes

Pgm Load allows you to choose whether programs will be loaded manually or automatically.

Pgm Load

Selecting **Manual** allows you to scroll through programs in Program mode, viewing them according to the DataBase criteria you've selected. Programs which are *not* loaded are identified by an asterisk (*) preceding the displayed name, and flashing of the **Program** button LED. Press **Program** to load the displayed program.

Selecting **Auto** (the default setting) will cause programs to be loaded automatically following a brief timeout whenever they are selected in **Program** mode.

Mix Each MPX 1 program has its own Master Mix and Level parameters, as well as individual mix and level settings for each Effect. These settings are stored as integral parts of the program. The **Mix** parameter allows you to select **Program**, to have each program load with its own master mix setting, or **Global** which allows any program Master Mix setting to become the global setting for all subsequently loaded programs.

Note that you can alter the global setting at any time by pressing **Mix** and changing the **Mix** setting on the **Mstr Mix** and **Level** screen. Once you have altered **Mstr Mix**, subsequent programs will load with the new value as the global setting.

Bypass The **Bypass** parameter allows you to determine the behavior of the MPX 1 when the front panel **Bypass** button is pressed. When the **Bypass** button is pressed, it will light and a message will be briefly displayed to indicate that Bypass is on. Pressing **Bypass** again will briefly display the message that Bypass is off, and turn the button light off.

The choices available from the **Bypass Mode** menu are:

Bypass: Completely bypasses the MPX 1, passing unprocessed audio directly through to the outputs. (This is the default setting.)

All Mute: Mutes both the input and the output signal, giving complete silence.

Input Mute: Mutes the input to the MPX 1, allowing the tail of the effect to ring out.

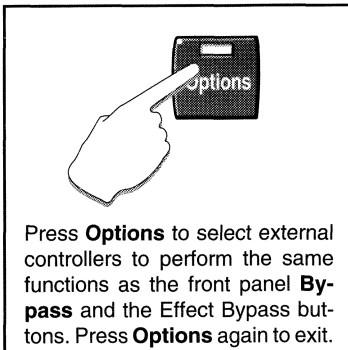

Option: Bypass Source Assignments

You can assign external controllers to activate Master Bypass and or Bypass for any of the six effect blocks: Pitch, Chorus, EQ, Mod, Delay or Reverb.

Press **Options** to display the Bypass Source list. Use the < and > buttons to select the bypass function: Mstr, Pitch, etc. Use the knob to assign the control you want to have activate the selected function. The choice of controllers is:

None (the default setting)

Tog 1-3

Sw 1-3

CC 1-31

CC 33-119

Pgm Bypass **Pgm Bypass** allows you to determine the behavior of the MPX 1 when a new program is loaded. The choices available are: **All Mute** or **Bypass**.

The MPX 1 gives you an exciting approach to working with delay times and modulation parameters. You can set these parameters in *beats*, allowing you to control your programs in a completely musical way. Each MPX 1 program has its own Tempo parameters, with tempo settings stored as an integral part of the program. These include Tempo Rate, Tempo Source (Internal or MIDI), Beat Value and Tap Source. The **Global** setting here allows you to override individual Tempo Rate settings with a global value which can then be changed on the fly.

When shipped, the MPX 1 has the Tempo Mode set to **Program**, with each program driven by its own stored tempo rate. To change to a global tempo rate, select **Global** here.

Whether **Tempo Mode** is set to **Global** or **Program**, you can set a new tempo rate by pressing the front panel **Tap** button twice. Alternatively, you can choose to have tempo set automatically from incoming MIDI clock. The rate you tap, or the MIDI tempo, will become the global setting.

For more information about working with the tempo parameters, see Chapter 3: *Editing*.

The MPX 1 provides a memory protection feature to prevent accidental overwriting of your stored programs. When this control is set to **On**, attempting to store a program will cause the Store process to abort, and an error message to be displayed. To enable the Store function, select **Off**. (This is the default setting.)

Option: StorePrompt

To have the MPX 1 warn you whenever loading a new program would erase changes you have made but have not saved, press **Options** and set **StorePrompt** to **On**.

This control allows you to adjust the contrast of the alphanumeric display along a range of 0-15.

The setting of **Sleep** mode determines the behavior of the MPX 1 when it is left idle. When it is on, a set of messages is cycled across the display. Like a computer screen saver, any activity on any panel control will automatically return the MPX 1 to normal operation. When shipped, **Sleep** is set to **English Promo** for display of MPX 1 features. You can change this mode to display feature messages in other languages, to display general **Help** messages, or you can turn the messages completely **Off**.

Tempo Mode

Memory Protect

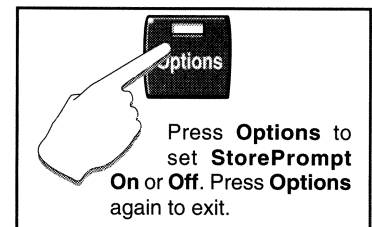

Contrast

Sleep

Setup Load and Setup Store

A set of parameters from System mode, including audio parameters, Modes, MIDI parameters and your current DataBase sorting method are collectively called a "Setup". Five Setups can be stored in the unit, allowing you to quickly reconfigure the MPX 1 at any time. The **Setup Load** and **Setup Store** controls allow you to save your current configuration as **Setup 1-5** and to reconfigure the MPX 1 to any of these stored states.

When the MPX 1 is shipped (or when you reinitialize the unit) default values are assigned to the Setup parameters. The following table shows these parameters and the factory default setting of each.

Menu	Parameter	Default Setting	
Program	Database Sort	by Number	
System	Audio	Input/clck	Analog/Int
		Input Mode	Stereo
		Output Mode	Analog
		Dig In Lvl	0dB
		ChanStatus	Generate CS
		Soft Sat	Off
	Modes	Pgm Load	Auto
		Mix Mode	Global
		Bypass Mode	Bypass
		Master Bypass Src	None
		Pgm Mode	Bypass
		Tempo Mode	Program
		MemProtect	Off
		StorePrompt	Off
		Contrast	10
		Sleep	English Promo
		MIDI	Pgm Change
	Pgm# Offset		1
	Receive		1
	Transmit		1
	Pgm Change		On
	Pgm+		Off
	Pgm-		Off
	Ctl Send		None
	Ctl Smooth		100
	MIDI Clock		Off
	Automation	Off	
Xmit ID	0		
SysEx	On		
Receive ID	0		
Xmit Speed	Fast		

To load a Setup, select **Setup Load** from the **System Modes** menu.



The LED in the **Store** button will flash. When you press **Store** the display will show:

**Load #n: Setup1
(Press Store)**

The upper line of the display shows the Setup number currently selected for loading. Turn the knob to select any Setup number 1-5. Press **Store** again. The display will show:

New setup loaded

Then the MPX 1 will return to normal operation with the new Setup parameters in effect.

The procedure for storing a new Setup is almost identical, but includes the option of assigning a name to your Setup. Select **Setup Store** from the **System Modes** menu.

**Modes: Setup Store
< (Press Store)**

The LED in the **Store** button will flash. When you press **Store** the display will show:

**Setup 1
#1; Setup 1**

Use the < and > buttons to move an underbar cursor to anyone of 9 characters available in the upper line for naming, or to the Setup # in the lower line.

The upper line shows a default Setup name (**Setup 1** in our example). The lower line shows a Setup number (1-5) and the current name of that Setup. The < and > buttons move an underbar cursor in the display from each one of the nine characters available for the name, to the # on the bottom line. The knob selects alphanumeric characters at each cursor location.

Once you've made changes to the Setup name or selected a new number for it, press **Store** again. The display will show:

**Are you sure?
Yes or No**

To store your new Setup, press **Yes**. To return to the **Setup Store** display without saving the Setup, press **No**.

MIDI This menu contains all of the MPX 1 **MIDI** controls. The operation of each of these controls is described here. More information on working with MIDI is presented in Chapter 6.

Program Change

The **Pgm Change** control allows you to enable or disable the Reception of MIDI Program Change messages. The manner in which the MPX 1 interprets these messages is determined by your selection here.

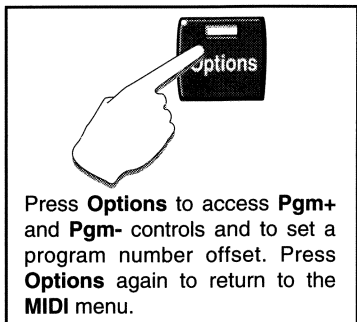

- Off** All Program Change and Bank Select messages are ignored. **Pgm +** and **Pgm -** will load the next higher or lower program.
- On** Program Change messages 0-99 correspond to MPX 1 programs 1-100.

Options: Pgm# Offset, Pgm+ and Pgm-
Pressing **Options** from the **Pgm Change** display allows you to offset MPX 1 program numbers to match another MIDI device.

From **Options** you can also map **Pgm+** and **Pgm-** controls to load the next higher or lower program. The following sources can be selected to activate these controls:

- None
- Tog 1-3
- Sw 1-3
- CC 1-119

Receive Select **1-16**, **OMNI** or **Off** for receipt of MIDI messages.

Transmit Select **1-16**, or **Off** for transmission of MIDI messages.

Ctl Send If **Transmit** is active (set to any channel), you can select any of the controllers shown to the side to transmit MIDI controller messages if they are used in a patch.

Ctl Send Selections	
None	BTrg
On	ABTrg
Knob	Pedal
Puls1	Tog 1-3
Tri1	Sw 1-3
Sine1	CC 1-31
Cos1	CC33-119
Puls2	Bend
Tri2	Touch
Sine2	Vel
Cos2	Last Note
Rand	Low Note
Arp	High Note
ADR1-2	Tempo
S/H	Cmnnds
Env1-2	Gate
Mtr1-2	Trig
A/B	LGate
ATrg	TSW

The display presents two selection fields for mapping the controllers as shown below.



Two fields are available for mapping MPX 1 controls to MIDI controllers.

Options: MIDI Reset

The MPX 1 recognizes the “Reset All Controllers” MIDI message. When received, all patched parameters are reset to their stored values. Patched parameters may also be reset from the MPX 1 front panel—in **System** mode select **Ctl Send** from the **MIDI** menu and press **Options**, then press **Yes**. (The message will be transmitted from the MPX 1 as well). If you do not want to perform the reset, press **Options** to exit.

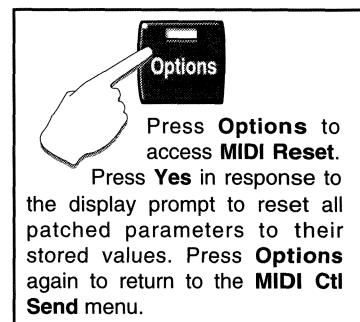

The **Ctl Smooth** parameter is an intelligent filter that provides a smoothing function for incoming MIDI data. At 100, the filter is essentially bypassed. With decreasing values, the filter becomes more sluggish in its response to small MIDI controller value changes while maintaining a fast response to large changes. This is useful for smoothly interpolating sparse MIDI controller data. As the value is lowered, the filter's response slows for both large and small MIDI controller value changes.

Ctl Smooth

You can choose to have the MPX 1 transmit MIDI Clock at the current tempo rate by setting this control to **On** and **Tempo Source** (in the **Edit** menu) to **Internal**. If this control is set to **Off**, MIDI Clock will not be transmitted.

Clock Send

This control is provided for control of one or more additional MPX 1s. Select **On** to have values resulting from front panel operations sent out as System Exclusive messages.

Automation**Options: Xmit Device ID**

Press **Options** to access the **Xmit Device ID** screen where you can select **0-126** or **All** to identify the target MPX 1s.

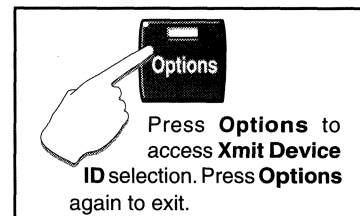

This control is provided for communication with one or more additional MPX 1s, or computer editor software. **On** (the default setting) allows System Exclusive messages to be received by the MPX 1.

SysEx**Options: Receive Device ID**

Press **Options** to access the **Receive Device ID** screen where you can select **0-126** to identify the MPX 1.

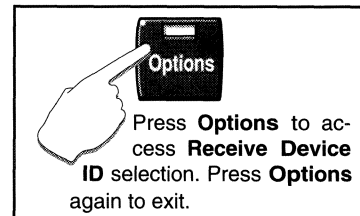

Dump This control allows you to perform MIDI dumps of **Current Pgm, All Programs, Map 1-3, Chain 1-10, Setup 1-5**. Select whichever of these categories you want, and press **Store**.

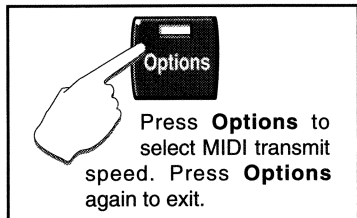

Options: Xmit Speed
 Press **Options** to select one of four MIDI transmission speeds (**Slow, Medium Slow, Medium Fast and Fast.**)

NOTE: The Device ID used in dumps is the current **Receive Device ID**.

MIDI Maps Program Change 0-127 can be mapped to any MPX 1 program. Three 128-element maps are available. When you select **MIDI Maps** from the System menu, you can select any one of the three maps and make your selections from screens like the ones shown below.

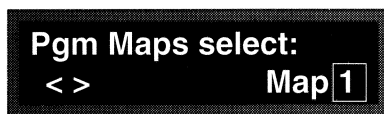

With the map number you want to work with displayed in the lower right of the display, use the < and > buttons to scroll to the mapping screen.

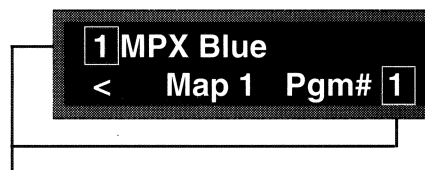

Select either of these two fields to display any MPX 1 program number (and the corresponding program name) on the top line, and the MIDI Program Change number you want the program mapped to on the bottom line.

Once you've created maps, you can make them active by setting the DataBase sorting option to **Show Members of MIDI Maps**. (Press **Program**, then press **Options**.)

Options: Unchanged, Start at n, Clear Map, and Clear n-n
 Press **Options** from either of the Map screens to access an additional set of controls which allow you to quickly alter map assignments.

- Unchanged:** Selections made in **Options** take effect immediately on returning to the Map menu. This selection allows you to enter and exit **Options** without effecting any change.
- Start at n:** This control allows you to completely reassign a map, starting with the program number selected here, and including the next consecutive 127 program numbers.
- Clear Map:** This control allows you to completely clear all assignments for the active map.
- Clear n-n:** This control allows you to completely clear only a specified section of assignments for the active map.

The MPX 1 has 10 internal program chains, each made up of ten "links". You can assign any program to any link in the chain with the controls in this menu. A chain can be loaded with a MIDI Program Change message, or by selecting **Members of Pgm Chains** as a DataBase sorting option and loading the chain from **Program** mode. When the **Members of Pgm Chains** is selected as a DataBase sorting option, use the < and > buttons (or MIDI Program Change numbers) to select a chain. Use the knob (or **Pgm+/Pgm-**) to load programs assigned to the selected chain.

Program Chains

Once a chain is loaded, the source assigned to **Pgm+** and **Pgm-** will load the next higher or lower program in the chain. The screens in the **Program Chains** menu allow you to select chains, and make chain and link assignments as shown below.



With the chain number you want to work with displayed in the lower right of the display, use the knob or the < and > buttons to scroll to the chain assignment screen.



Select the MIDI Program Change number (1-128) that you want to load the chain.

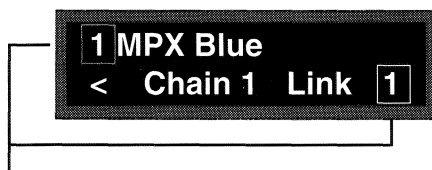

Select either of these two fields to display any MPX 1 program number (and the corresponding program name) on the top line, and the position you want the displayed program to occupy in the chain (Link 1-10) on the bottom line.

Options: Unchanged, Start at n, and Clear chain

Press **Options** from any of the Chain screens to access an additional set of controls which allow you to quickly alter chain assignments.

- Unchanged:** Selections made in **Options** take effect immediately on returning to the Chain menu. This selection allows you to enter and exit **Options** without effecting any change.
- Start at n:** This control allows you to completely reassign a chain, starting with the program number selected here, and including the next consecutive nine program numbers. This is particularly useful for creating chains from your own programs.
- Clear Chain:** This control allows you to completely clear all assignments for the active chain.

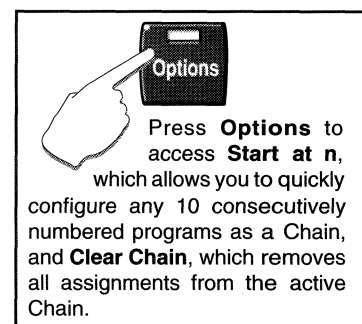

Initialize Selecting any item in the **Initialize** menu will restore portions of the MPX 1 to their factory default settings. These controls allow you to perform a complete reset of the unit to its factory defaults, or to reset only selected functions.

For any displayed selection, the initialization procedure is the same. When a selection is displayed, as in the **Initialize All** example shown below, the **Store** button LED will flash, indicating that the MPX 1 is armed to perform the reset procedure.

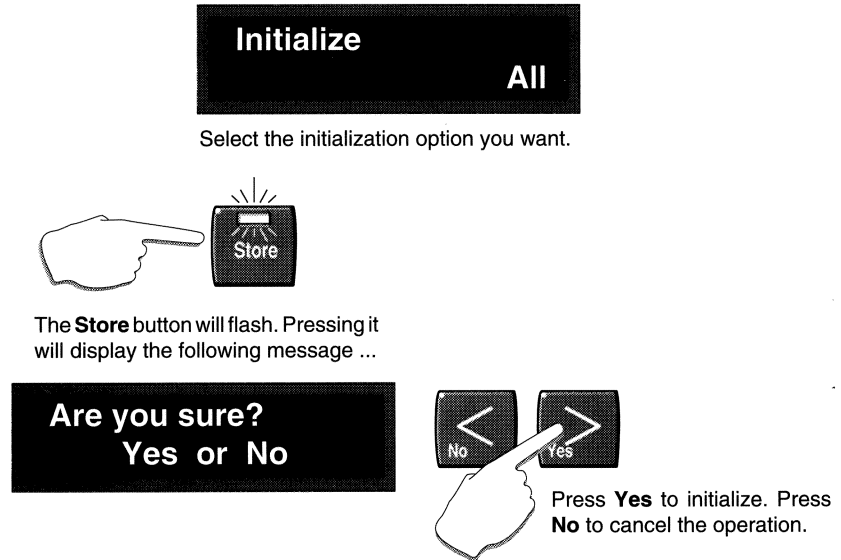

Press **Store**. The display query "Are you sure?" prompts you to select **Yes** or **No** as a response. If you don't want to perform the initialization, press **No** to cancel the operation. If you press the front panel **Yes** button in response to this message, the procedure will be performed immediately. The message **Init Complete** indicates that the procedure has been performed.

Note that the time for reinitialization will vary, with selections including DataBase reset taking more time.

The selections in this menu are as follows:

- All:** Resets all MPX 1 parameters to their original factory settings. **This will erase all User programs and Setups.**
- User pgms only:** Erases all User programs (program #s 201-250).
- System only:** Resets all MPX 1 parameters *except* User programs.
- Controllers:** Resets the MPX 1 internal controllers (Knob, LFOs, etc.) to their default settings.
- Bypass Patches:** Removes any patches made between **Bypass** buttons and external controllers.
- Global Patches:** Clears all global patches.
- DataBase:** Resets DataBase assignments for all programs. **This will remove DataBase assignments from programs 201-250.**

This control allows you to clear a single User program, or any number of consecutively numbered User programs.

Clear Programs

From the **Clear Programs** screen, press > to display the following screen.



Two fields are available for selecting any number of User programs between 201 and 250.

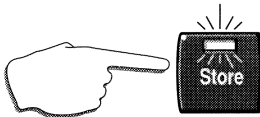

The **Store** button will flash. Pressing it will display the following message ...

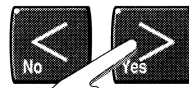
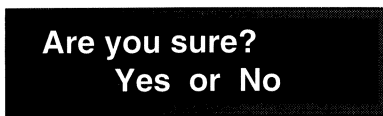

Press **Yes** to clear the selected programs. Press **No** to cancel the operation.

The **Store** button LED will flash, indicating that the MPX 1 is armed to perform the clear procedure. Press **Yes** to execute the clear operation. Note that this will override the Memory Protect function if it is on.

A displayed message indicates that the clear operation is complete. Press **System** to return to the main **System** menu.

Note that if you clear the active program, you can still use it and make modifications to it (including restoring it) until you load another program, at which time the clear action will take effect.

Copy Programs This control allows you to copy a single program, or any number of consecutively numbered programs into a new location in User memory (program #s 201-250). Selections you make here will overwrite programs currently at the location(s) you designate.

From the **Copy Programs** screen, press **>** to display the following screen.

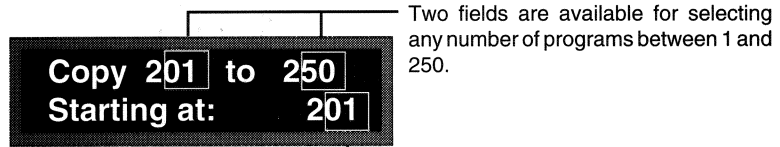

Select the location where you want the first of your selected programs to be placed. The remainder of the programs you have selected will be placed consecutively after this point.

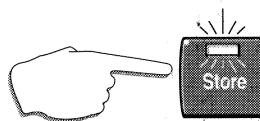

The **Store** button will flash. Pressing it will display the following message ...

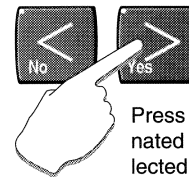
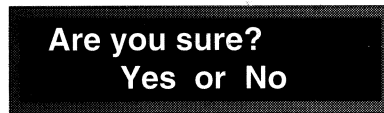

Press **Yes** to copy the designated programs into the selected location. Press **No** to cancel the operation.

The **Store** button LED will flash, indicating that the MPX 1 is armed to perform the copy procedure. Press **Yes** to execute the copy operation. Note that this will override the Memory Protect function if it is on.

A displayed message indicates that the copy operation is complete. Press **System** to return to the main **System** menu.

Global Patches

Ten global patch assignments are available which allow you to assign an external controller to the MPX 1 Master Mix or Master Level controls, or to individually control any one of the MPX 1 Effect Mix or Level controls. Global patches override, but do not clear, program patches with the same parameter Destination.

From the **Global Patches** screen, press > to display the following screen.

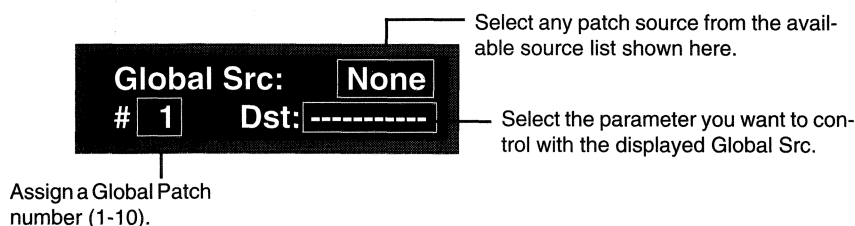

Use the < and > buttons to select one of the display fields shown above. Use the knob to assign a source, a destination parameter and a patch number.

When you've completed your selections, press **System** to return to the main **System** menu.

Options: **MIDI Learn** and **Dst Edit**

When **Global Source** is selected, pressing **Options** accesses a MIDI Learn function which automatically assigns any connected MIDI controller as the Source as soon as the controller is moved. Once you have moved the controller, press **Options** again to return to the **Global Patches** display.

When **Dst** is selected, pressing **Options** accesses a set of controls which allow you to edit all assigned Destinations.

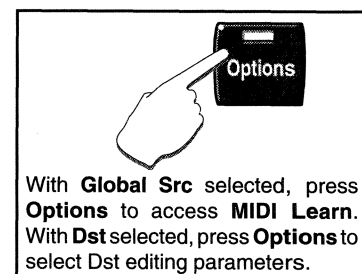

Unchanged: Selections made in **Options** take effect immediately on returning to the Global Patches menu. This selection allows you to enter and exit **Options** without effecting any change.

Clear All: This control allows you clear all Destination assignments.

Mix Params: This control allows you to assign Mix parameters to all Destinations.

Level Params: This control allows you to assign Level parameters to all Destinations.

Press **Options** again to return to the **Global Patches** display.

Calibrate Pedal This control allows you to achieve full range output of any connected 10k-100k continuously variable footpedal.

From the main **System** menu, select **Calibrate Pedal** and press **Yes**. A display prompt will allow you to choose to continue the calibration procedure, overwriting any pre-existing pedal settings, or to discontinue the procedure.

Pressing **Yes** in response to the display prompt displays:

A black rectangular box with white text that reads "Move pedal from min to max . . .".

Move your footpedal from its minimum to its maximum position. **127** should be displayed when you reach the maximum point of footpedal travel.

Press **Yes** to save the calibrated settings and to return to the **System** menu. Your settings will be stored as part of the current Setup.

To restrict the active range of a pedal, position the pedal within the desired range, then select **Calibrate Pedal** and press **Yes**. When the display prompts you to move the pedal, move it only within the restricted range, then press **Yes**. Once calibrated, any pedal positions below the range will produce pedal controller values of 0. Positions above the range will produce values of 127.

The pedal jack will also work with control voltages as high as 0-10V, or as low as 0-1V. When prompted to move the pedal, move the control voltage between its minimum and maximum values, then press **Yes**. Refer to Chapter 1: *Product Overview* for pedal wiring information.

MIDI Operation

All MPX 1 parameters and programs can be accessed by MIDI. All MIDI applications require the MPX 1 to be connected with one or more MIDI devices with standard MIDI cables via the rear panel MIDI jacks.

Selecting a MIDI Channel

MIDI controls, such as Transmit and Receive Channel selection are available in the **System** mode **MIDI** menu. All of these controls are described in Chapter 5: *System Controls*. Several are repeated here for your convenience.

Before using the MPX 1 with other MIDI devices, all devices must be set to the same MIDI channel. To set the MPX 1 to receive MIDI:

1. Set the controller you will be using (keyboard, sequencer, other MPX 1, etc.) to transmit on any MIDI channel (1-16).
2. On the MPX 1, press **System**. Use the knob to scroll to the **MIDI** menu. Use the < and > buttons to select **MIDI Receive**.
3. Use the knob to select **OFF**, **1-16**, or **OMNI** for receipt of MIDI messages.

Accessing Programs

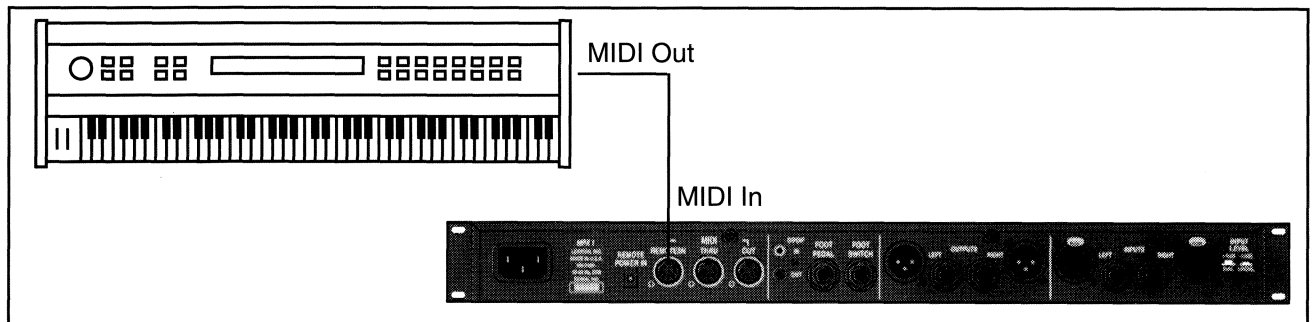

Some extremely useful effects can be created by controlling MPX 1 parameters remotely in real time. Almost all of the controllers found on a MIDI keyboard or MIDI foot controller (pitch benders, mod wheels, sliders, switches, breath controllers, foot pedals and footswitches) can be used to adjust MPX 1 parameters. We refer to this real time remote control capability as Dynamic MIDI.®

Sending a MIDI Program Change message (0-99) from the controller will load the corresponding MPX 1 register. If any MIDI sources are active as global or general purpose patches, moving the appropriate control on the controller will cause the patched destination parameter to change. (See Chapter 4: *Patching*.) If you want to use Dynamic MIDI, but don't want the MPX 1 to load new registers when you change programs on your controller, set your controller so that it doesn't transmit Program Change messages, or set MPX 1 **Pgm Change** to **Off** in the **System** mode **MIDI** menu.

Controlling MPX 1 Tempo Rate with MIDI Clock

MIDI Tempo Control

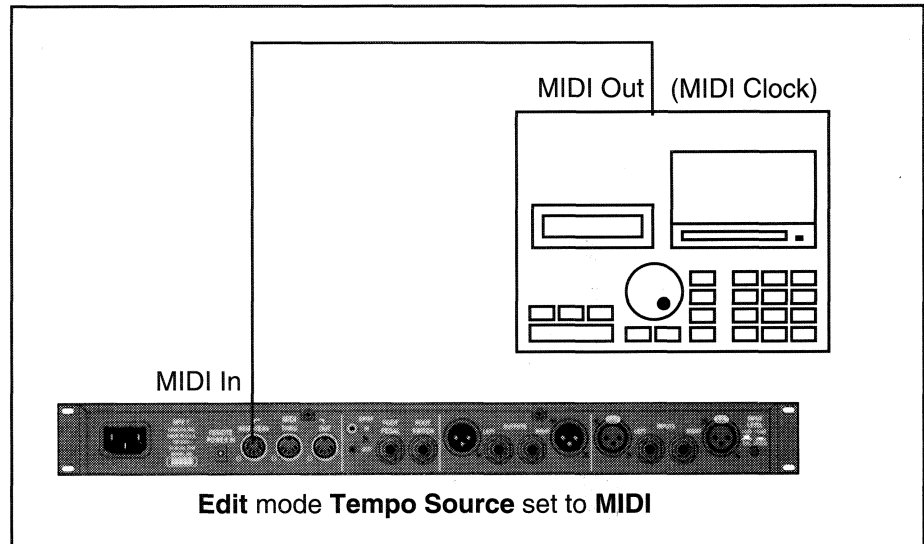

Using the MPX 1 as a MIDI Clock Source

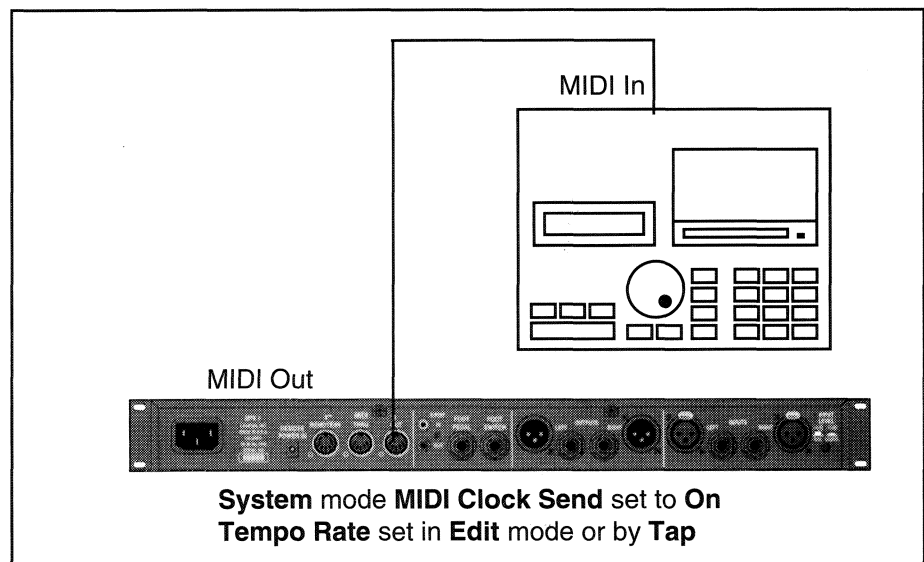

The configuration below shows the MIDI connections for controlling the MPX 1 simultaneously with MIDI Clocks from a sequencer, and messages from another MIDI controller. Note that the controller is set to "local control off" and the sequencer is set to "echo input".

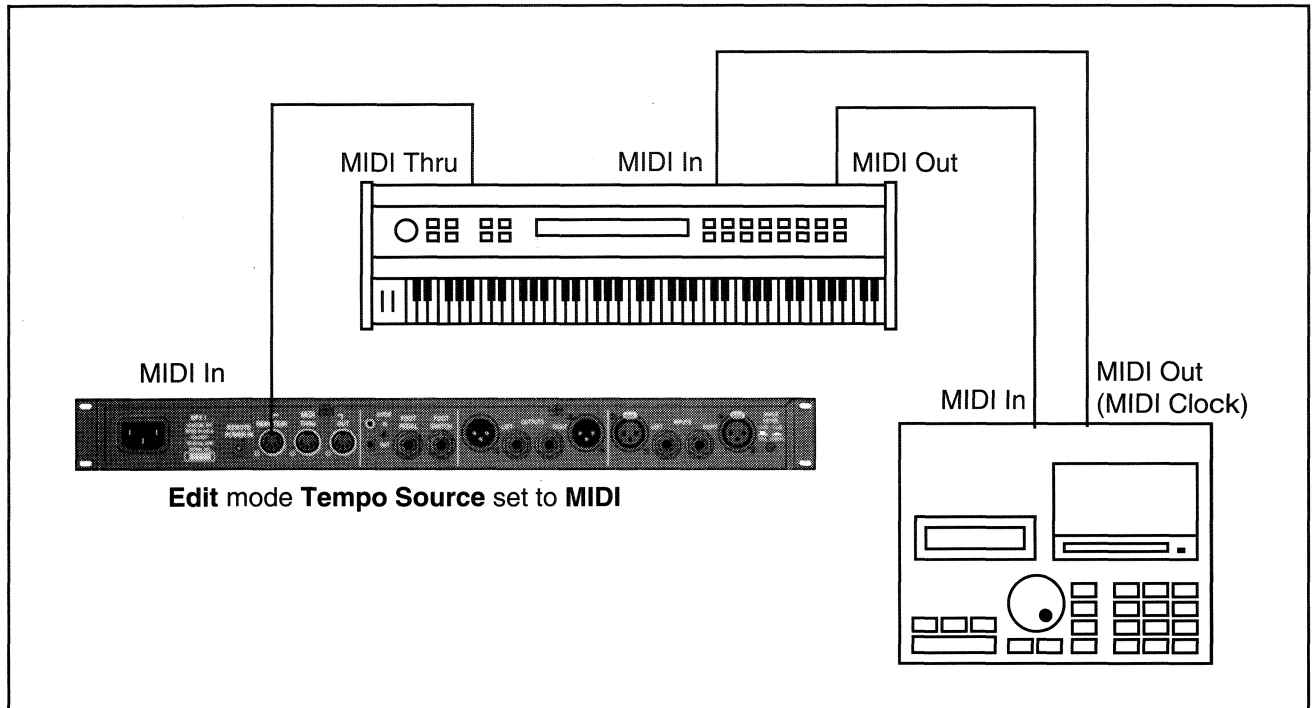

Two MPX 1s can be slaved together by connecting a cable from the MIDI OUT jack of the master to the MIDI IN jack of the slave. Additional MPX 1s can be slaved to the master by connecting a cable from the MIDI THRU port of one slave unit to the MIDI IN port of the next unit.

Slaving two or more MPX 1s

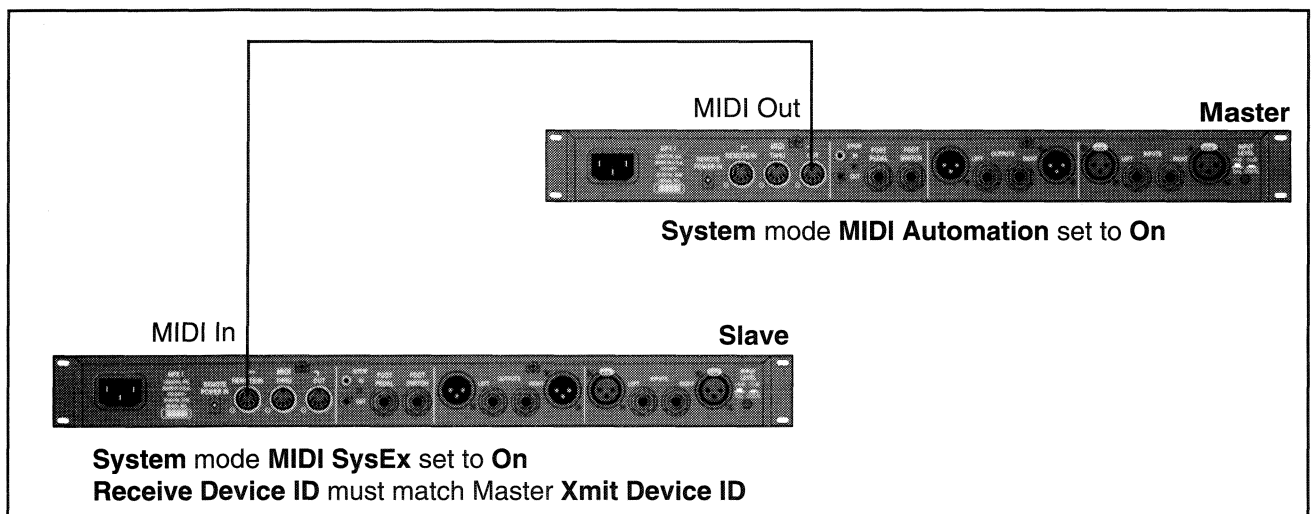

Controller Quirks

Some synthesizers and controllers cannot send the full range of MIDI program change messages (1-128). Others may appear to be able to send only 32, but actually have a bank mode that *does* let you send all 128 program change messages. Also, be aware that some MIDI devices use a program numbering system that uses 0-127 instead of 1-128. If in doubt, see the manual for your controller.

The Knob, Footpedal and Footswitch as MIDI Controllers

If the Knob, footpedal, or footswitch is active in the current program, you can choose to have the MPX 1 send MIDI Controller messages whenever you adjust it. This makes it possible to record real-time control of MPX 1 effects with a MIDI sequencer — A simple but quite powerful way to automate effects.

To send MIDI data from a controller, first create a patch using the controller, then set **System** mode **MIDI Xmit** to the desired MIDI Channel. (The default is Channel 1.)

Once a transmit channel has been set, go to **System** mode **MIDI Ctl Send** to assign MIDI Controllers. The display will show MPX 1 controllers and parameters in one field, and MIDI controller output selections in another field. (The default assignments are **None**.)

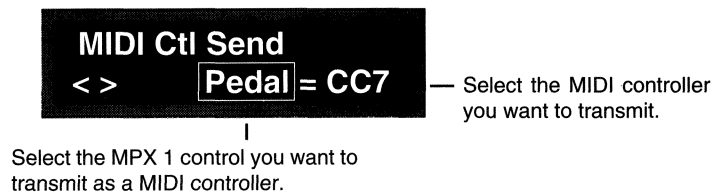

The MIDI Controller messages transmitted by MPX 1 controllers can be recorded in any MIDI sequencer. Once recorded, they can be played back to control the MPX 1 (and other MIDI devices) in real time. To control the MPX 1 from recorded controller messages, reassign the patch sources to the controller value that was assigned to **Ctl Send** in the **System MIDI** menu.

The procedures for recording footpedal movements on a MIDI sequencer, then using the sequencer to control the MPX 1, are given below as an example:

To transmit pedal moves to the sequencer:

- Create a patch that uses **Pedal** as a source to control the desired parameter.
- In the **System MIDI** menu, select **Ctl Send** and assign **Pedal** to any controller (for this example, use **CC4**.)

To automate the MPX 1 from the sequencer:

- Change the patch source from **Pedal** to **CC4**.

The Arpeggiator

The MPX 1 has a full featured MIDI arpeggiator. It processes held notes received from MIDI IN and transmits them as arpeggios through MIDI OUT. You can process the output of the sound generator through the MPX 1, but this is not necessary to hear the effect of the arpeggiator.

To use the arpeggiator, first make the MIDI connections:

- Connect a keyboard or other source of MIDI notes to the MPX 1 rear panel MIDI IN.
- Connect the MPX 1 rear panel MIDI OUT to a MIDI sound generator.
- Make sure everything is on the same MIDI channel.

At this point you can load either of two presets that have the arpeggiator connected (**MIDI Arp 1**, or **MIDI 16th Arp**), or you can set up the arpeggiator from scratch.

To set up a basic arpeggiator:

- Press **Edit** to display the **Edit Select** menu and select **Arp**.
- Set the Arp parameters as follows:
 - Mode: Up-Dn
 - V Src: 0
 - Clock: Puls1
 - OnSrc: LGate
 - OnLvl: 64
- Press **Edit** to return to the **Edit Select** menu and select **LFO 1**.
- Set the LFO parameters as follows:
 - Mode: On
 - Rate Options: cycles : beat
 - Rate: 2:1
 - PW: 50%
 - Depth: 100%

Play two or more notes at once on the MIDI keyboard and you will hear them arpeggiated on the sound generator. Press **Tap** twice to change the arpeggiation rhythm. Change the **Arp Mode** parameter to hear different note orderings. Change **LFO1 PW** to experiment with staccato and legato phrasing.

Program Change Messages

Reception of MIDI Program Change and Bank Select messages can be selectively enabled/disabled from the **System** mode **MIDI** menu. The manner in which the MPX 1 interprets these messages is determined by the value of this parameter as follows:

Pgm Change: Off

All Program Change and Bank select messages are ignored. Pgm+ and Pgm- controllers will load the next higher or lower program in the current bank.

Pgm Change : On

Program Change messages 0-99 correspond to MPX1 programs 1-100. Program Change messages 100—127 are ignored except when MIDI maps or chains are active.

Pressing **Options** from the **Pgm Change** display allows you to select a **Pgm# Offset** (to allow matching of MPX1 program numbers to another MIDI device) or to map **Pgm+** and **Pgm-** controls to load the next higher or lower program in the current bank.

Controller 32 is used to select Banks.

Program memory is organized into three banks as follows:

Program Bank 1	Preset programs 1-100
Program Bank 2	Preset programs 101-200
Program Bank 3	User programs 201-250

Three 128 element MIDI maps are stored internally. Program Change 0-127 can be mapped to any MPX 1 program. When first shipped, the MPX 1 has each map loaded with the following defaults:

Map 1, 2 or 3

MIDI 1 = Program 1
MIDI 128 = Program 128

Pgm+ and Pgm- will load the next higher or lower program in the map.

Any Program Change number can be selected to load any one of ten customized effect "chains." Once a chain is loaded, effects in the chain are accessed by the controller patched to Pgm + and Pgm - (program increment and program decrement).

Automation

SysEx Automation

The MPX 1 will transmit SysEx automation messages when the **System** mode **MIDI Automation** parameter is set to **On**. Virtually all changes made by front panel operations are transmitted as MPX 1 SysEx messages. This is intended primarily for use by editor programs and in configurations where it is desirable for one or more MPX 1s to be slaved to a single MPX 1 acting as a master. The current mode (Program, Edit or System) of the slave does not follow the master, but the actual parameter values do. (SysEx automation can also be stored on a sequencer and replayed in real-time. As a general rule, automating more than two or three SysEx parameter changes at once is not recommended.)

To set up the MPX 1 to receive SysEx automation messages from another MPX 1, or from a computer editor/sequencer, the transmitting and receiving MPX 1s should be set up as follows:

Transmitting MPX 1: **System** mode **MIDI Automation** set to **On**
 Receiving MPX 1: **System** mode **MIDI SysEx Receive** set to **On**

The **Receive Device ID** of the receiving MPX 1, and the **Xmit Device ID** of the transmitting MPX 1 must match. The **Receive Device ID** is an Option of the **MIDI SysEx Receive** parameter. The **Xmit Device ID** is an Option of the **MIDI Automation** parameter.

For applications where it is desirable to "automate" changes made to MPX 1 effects with its own controls (the knob, Footpedal or Footswitch), we recommend assigning the controllers to MIDI destinations (see Chapter 5: *System Controls MIDI Send*) and recording the MPX 1 MIDI output with a MIDI sequencer.

Controller Automation

The MPX 1 recognizes the "Reset All Controllers" message. When received, all patched parameters are reset to their stored values, or to the last front panel-edited values. Patched parameters may also be reset from the MPX 1 front panel—in **System** mode select **Ctl Send** from the **MIDI** menu and press **Options**. (The message will be transmitted from the MPX 1 as well).

Reset All Controllers

The MPX 1 recognizes incoming MIDI clock messages when the **Edit** mode **Tempo Source** parameter is set to **MIDI**. Any Delay parameter set to echoes:beat, or any LFO parameter set to cycles:beat, will be synchronized to the tempo of the incoming MIDI clock.

MIDI Clock and Clock Commands

MIDI Clock and Clock Commands (Start, Stop, Continue) are also available as Dynamic MIDI patch sources. The value of MIDI Clock when used as a patch source is a linear scaling of 0 to 127 (0 = 41 BPM and 127 = 400 BPM). The value of Clock Commands when used as a Dynamic MIDI patch source is 1 for START and CONTINUE and 0 for STOP.

Dynamic MIDI The following MIDI controllers are available as Dynamic MIDI patch sources:

MIDI Controllers	
1-31, 33-119	Continuous or switches: 0–127
Pitch Bend	0=max flat, 64=no bend, 127=max sharp
After Touch	Channel pressure: 0–127
Velocity	Note On velocity value of last received note: 1-127
Last Note	Note Number value of last received note: 0-127
High Note	Note Number value of highest note when more than one note is on: 0-127. (Same value as Last Note when only one note is on.)
Low Note	Note Number value of lowest note when more than one note is on: 0–127. (Same value as Last Note when only one note is on.)
Tempo	MIDI or internal tempo ranging from 41–400 BPM converted to a continuous range of 0–127.
Clock Commands	MIDI Clock commands received as a switch: Start and Continue=127, Stop=0
Gate	Generates 127 when any note is on and 0 when all notes are released.
Trigger	Generates a pulse (0, 127, 0) everytime a Note On is received.
Legato Gate	Generates 127 whenever two or more notes are on and 0 whenever fewer than two notes are on.
Touch Switch	Toggles between 0 and 127 whenever After Touch rises above 32 (allowing After Touch to be used as a latching switch).

These MIDI controllers are also available as threshold sources for several modulation parameters such as ADR1 and 2. They may also be used as a tap source for controlling Tempo.

MIDI Implementation Details, including System Exclusive documentation, are available to assist experienced programmers in developing software for use with the MPX 1. These can be obtained directly from Lexicon.
Request: MPX 1 MIDI Implementation Details.

Bulk Data Dumps The **System** mode **MIDI** menu provides a **Dump** control which allows selection of the following types of bulk data to be dumped directly from the MPX 1 to another MPX 1, or to editor/librarian software. **Options** allows you select MIDI transmit speeds of Slow, Medium Slow, Medium Fast or Fast.

Displayed Name	Description
CurrentPgm	Currently running effect
All Programs	
Map 1-3	Internal Program Change Maps
Chain 1-10	Internal Program Chains
Setup 1-5	Internal Setups

With the dump type you want displayed, press **Store** to transmit the data .

MIDI Implementation Chart

Lexicon MPX 1
Digital Effects System

Function		Transmitted	Recognized	Remarks
Basic Channel	Default Changed	1 1-16	1 1-16, OMNI	
Mode	Default Messages Altered	Mode 1 X	Mode 1, 3 X X	
Note Number		0-127	0-127	Last Note, Low Note, High Note, LGate, Gate, Trig used as controllers
Velocity	Note ON Note OFF	O X (Off-9n v=0)	O	used as controller
After Touch	Keys Channel	X X	X O	TSW and Touch used as continuous controllers
Pitch Bend		X	O	used as controller
Control Change	1-119	OX	OX	1-119 for MIDI transmit 0, 32 for Bank Select
Program Change	Bank Select	O O	0-99=1-100 O	100-127 ignored in Program mode 0-127 recognized for MIDI maps MIDI maps selectable via Bank Select
System Exclusive	Lexicon Real-time non Real-time	OX X Device ID	OX X Device Inquiry	product ID=09 Device ID
System Common	:Song Pos :Song Sel :Tune	X X X	X X X	
System Real Time	:Clock :Commands	OX X	OX OX	START, STOP and CONTINUE are patchable as a switch: START/CONTINUE=127; STOP=0
Aux Messages	:Local ON/OFF :All Notes OFF :Active Sense :Reset All Controllers	X X X OX	X O X OX	
Notes				

Mode 1: OMNI ON, POLY
Mode 3: OMNI OFF, POLY

Mode 2: OMNI ON, MONO
Mode 4: OMNI OFF, MONO

O : Yes **OX: Selectable**
X : No

The Effects and Parameters

The MPX 1 contains a library of 57 effects, each of which is described in detail in this section.

The effects are organized into six effect types corresponding to the Effect Selector buttons on the front panel (Pitch, Chorus, EQ, Mod, Delay, and Reverb). All of the effects available in each category are listed below.

Pitch	Chorus	EQ	Mod	Delay	Reverb
Detune (M)	Chorus	1-Band (M)	Panner	Delay (M)	Chamber
Detune (S)	Flanger (M)	2-Band (M)	Auto Pan	Delay (S)	Hall
Detune (D)	Flanger (S)	3-Band (M)	Tremolo (M)	Delay (D)	Plate
Shift (M)	Phaser	4-Band (M)	Tremolo (S)	Echo (M)	Gate
Shift (S)	Rotary Cab	1-Band (S)	Overdrive	Echo (S)	Ambience
Shift (D)	Aerosol	2-Band (S)	Volume (M)	Echo (D)	
Volume (M)	Orbits	1-Band (D)	Volume (S)	Looper	
Volume (S)	Centrifuge1	2-Band (D)	Volume (D)	Ducker	
Volume (D)	Centrifuge2	Sweep Filter			
Test Tone	Comb 1	Wah			
	Comb 2	Fc Splitter			
		Crossover			
		2-Tone (M)			
		2-Tone (S)			
		2-Tone (D)			
		3-Tone (M)			
		3-Tone (S)			
		3-Tone (D)			

Lighted effect buttons indicate which effect blocks are active and turned on in the currently loaded program. (Effects can be active, i.e. available for use in a program, but bypassed and, therefore, "off".) To identify the particular effect which is running, press and hold any of the effect buttons. A message informs you if the effect block is active, or not. The name of the particular effect in use in an active block is identified by name.

To access the edit parameters of any active effect, press **Edit**, then select the effect by pressing the appropriate button. Use the knob and the < and > buttons to select and modify the effect parameters. Press **Edit** again to return to the Edit menu. See Chapter 3: *Editing* for more information.

**Notes on
Combining Effects**

Different effects require different amounts of MPX 1 processing. The following notes should be kept in mind when creating new combinations of effects in a program.

All reverb effects have dedicated processing and can be used in combination with any other effect. (You can always add any reverb to any MPX 1 program.)

The Pitch, Chorus, EQ, Mod and Delay effects share processing resources. This means that some combinations of these effects may not be possible—depending on which effects are already loaded. If you attempt to load an effect that requires more resources than are available, an error message will be displayed.

The Detune, Shift, Chorus, Flange, Rotary, Orbits, Centrifuge and Comb effects require dedicated processing resources for delay interpolation. Only one of these effects can be active at any given time any MPX 1 program.

Notes on the processing requirements of other specific effects is given in the following description whenever applicable.

**Notes on
Controlling Effect
Parameters**

Any effect parameter in the MPX 1 can be patched for real time control. In some cases, audible artifacts may be produced, depending on the particular parameter and the rate and range of control. In many effects, we've added additional processing power to parameters that are obvious candidates for drastic dynamic control. These parameters are "interpolated" to produce extremely smooth, noise free control.

It is often possible to compensate for a non-interpolated parameter, such as Pitch Detune Level, by combining the effect block with one with an interpolated Level parameter, such as Mod Volume.

**Notes on
the Effect
Descriptions**

In the following effect descriptions, interpolated parameters are indicated by an asterisk (*) following the parameter name.

Examples of presets which use the effect are listed at the end of each description.

In the Pitch effects: Detune (M), (S) and (D) and Shift (M), (S) and (D), Tune controls the amount of pitch shift. The Optimize parameter (an option of Tune) allows balancing of any artifacts vs. the amount of delay through the effect. Higher settings of Optimize are good for chords and low notes, lower settings minimize the delay through the effect.

A set of Volume effects: Volume (M), (S) and (D) are included in this block for convenience when constructing programs that don't use pitch effects. A sine wave generator (Test Tone) is also included to allow generation of test tones, tuning, etc.

Pitch Effects

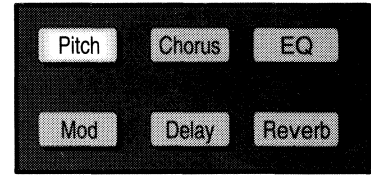

Pitch Detune (M), Detune (S) and Detune (D)

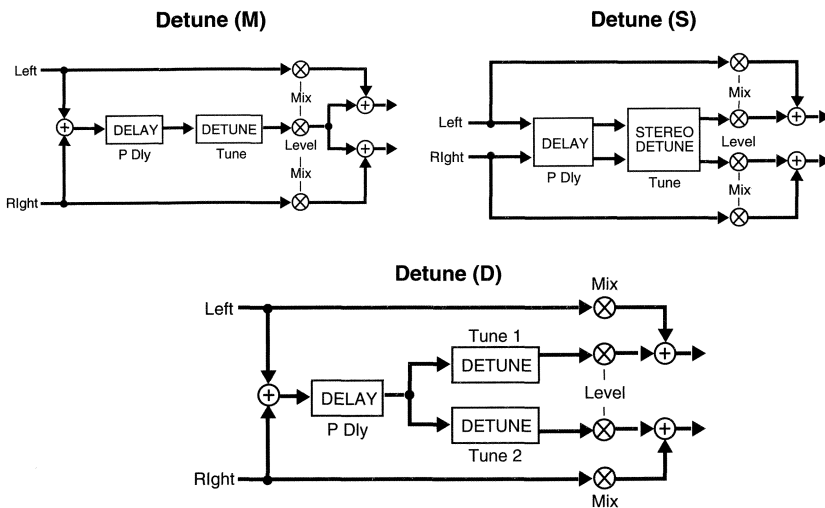

Mix	0-100%	Dry/Wet ratio
Level	Off, -89 to +6dB	Amount of effect in the processed signal
Tune, Tune1, 2	0-100	Pitch shift
(Optimize)	10-60ms (M), (D) 10-40ms (S)	An option of Tune 1 — Adjusts the amount of delay in the tuner
P Dly	0-70ms (M), (D) 0-25ms (S)	Amount of delay before the onset of the effect

As the detune effects use up relatively few processing resources, they can be combined with reverb and many other effects. When creating effects that don't require pitch shifting by large intervals (semitones) the detuners are the most efficient choice.

Detune effects are useful for thickening up sounds by adding delayed/pitch shifted versions of the original source. They can be particularly effective when used to simulate double-tracking. They are also great alternatives to chorus effects as a detuner can add the richness of a chorus effect without the audible sweep caused by the chorus rate. Detuners are also traditionally used to turn a six-string guitar into a twelve-string, or an in-tune piano into a honky-tonk. The MPX 1 detuners are optimized to provide very fine amounts of pitch shift.

Detune (M) is a single-channel detuner that creates a pair of signals, pitch-shifted up and down from the input. The pair is always mixed together, and presented equally to the outputs.

Detune (S) creates a pair of signals, pitch-shifted up and down from the inputs. The left and right channels are separate.

Detune (D) sums left and right inputs to mono, then creates two pairs of signals, pitch-shifted up and down from the inputs by Tune1 and Tune 2. The first pair goes out the left, the second pair out the right.

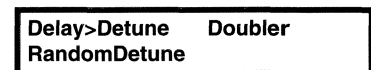

* = Interpolated; () = Option of preceding parameter

Pitch Shift (M), Shift (S) and Shift (D)

The pitch shift effects are designed to provide both fine (1 cent resolution) and coarse (semitone resolution) pitch shift effects. Use them to create harmonizations, detuning, or special effects. The Tune parameters can be glided smoothly across their entire range. Try controlling Tune with a foot pedal or MIDI controller for "whammy-bar" and pedal steel effects with guitars.

Shift (M) is a single-channel pitch shifter.

Shift (S) is a stereo version of **Shift (M)** with synchronized crossfades.

Shift (D) provides mono input to two independent pitch shifters controlled by Tune1 and Tune 2. The first shifter goes to the left output, the second to the right output.

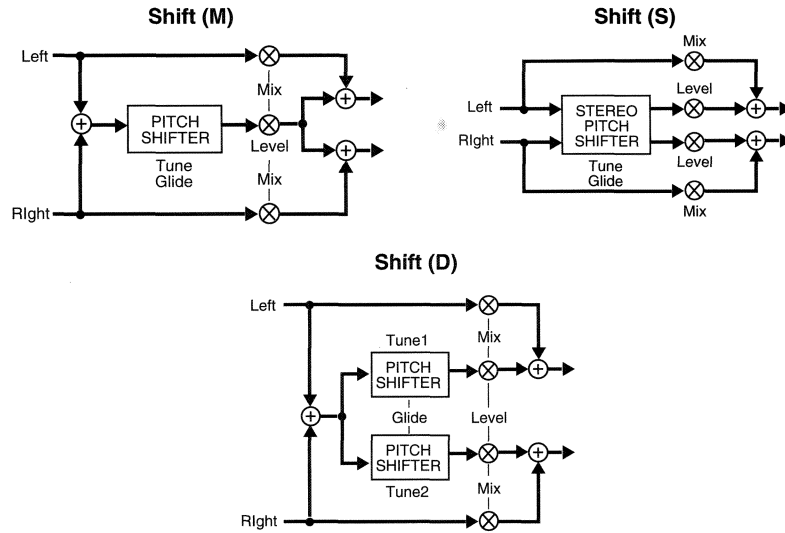

Mix	0-100%	Dry/Wet ratio
Level	Off, -89 to +6dB	Amount of effect in the processed signal
Tune	-4800 to +1900 cents	Pitch shift
(Optimize)	0-100	Adjusts the amount of delay in the pitch shifter
Glide	Off, On	Coarse, fine resolution of pitch shift

These effects use more processing resources than the detuners. Shift (S) and Shift (D) are among the largest effects in the MPX 1.

ClassicDetune 5th Plate Wet Triads

Pitch Volume (M), Volume (S) and Volume (D)

The Volume effects can be placed in front of, or behind, other effect blocks to provide smooth level control through a 95dB range. You can use them for dynamic input or output control, EQ input trim (helpful when adding large amounts of gain with an EQ effect), stereo to mono mixer, cross fade controls, volume pedal, etc.

In **Volume(M)** the left and right inputs are mixed together, then sent to both outputs through a volume control.

In **Volume (S)** the left and right inputs are sent through a ganged pair of volume controls.

In **Volume (D)** the left and right inputs are sent through independent volume controls.

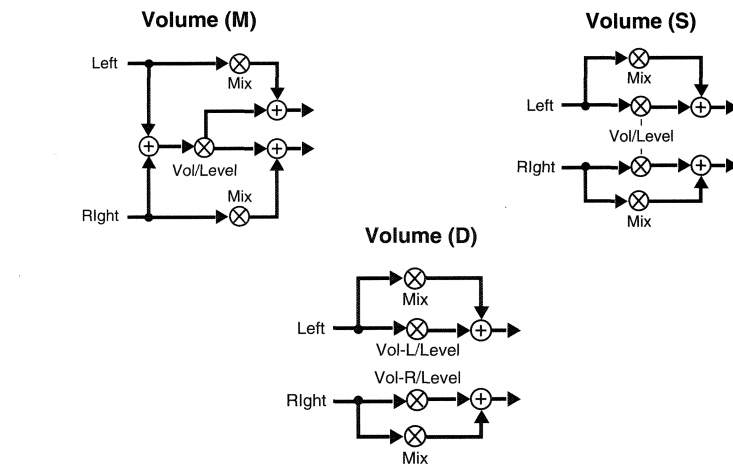

Mix	0-100%	Dry/Wet ratio
Level*	Off, -89 to +6dB	Amount of effect in the processed signal
Vol*	0-100%	Amount of effect in the processed signal

ChrsRvbMorph Volume Pedal

* = Interpolated; () = Option of preceding parameter

Pitch
Test Tone

Mix	0-100%	Dry/Wet ratio
Level*	Off, -89 to +6dB	Amount of effect in the processed signal
Note	C0-G10	Sine wave pitch, expressed as MIDI notes (0=C0, 127=G10)
Bal*	-50 to +50	Relative level of left and right output attenuation

Handy pitches:
D#0=19.445Hz A4=440Hz B5=987.77Hz D#8=4978Hz D#9=9956Hz

Test Tone is an audio sine wave generator with its output quantized to correspond with the pitches of a chromatic scale (A = 440 Hz) over a nine-and-one-half octave range. It is provided primarily as a convenient way of generating test tones and tuning references.

The Level and Note parameters allow it to be used in musical and sound effect applications as well. It can be "played" from a MIDI keyboard or sequencer by patching Last Note to Note and an ADR to Level (use MIDI Gate to trigger the ADR). Other useful patch sources for controlling pitch include: S/H, MIDI Arpeggiator and the Random Generator.

Bal controls the relative level of left and right output attenuation. When Bal=-50, the left output has no attenuation, and the right output is fully attenuated. When Bal=0, neither output is attenuated. When Bal=+50, the left output is fully attenuated and the right output has no attenuation. Level and Bal can be patched to a global LFO to get tone bursts, etc. Pitch accuracy is better than 1/4 cent.

Big Bottom 50's Sci Fi

* = Interpolated; () = Option of preceding parameter

Chorus Effects

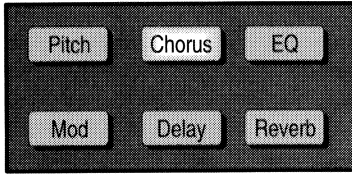

The chorus effects are generally used to enhance a sound by modulating delay times and/or frequency content in various ways. Of course, the classic effects of this type : Chorus, Flanger and Phaser are all here – along with several other variations such as: Rotary Cab, Aerosol, Orbits, Centrifuge, Comb 1 and Comb 2.

All of the Chorus effects have one or two resonance parameters. These parameters control the level and phase of the effect output signal that is recirculated into the effect inputs. Use care when adjusting these parameters, as they can cause overload (or feedback-like howls) if they are set too high — even with little or no input signal present. As a general rule, the combined value of any resonance parameters should always be less than 100 — but pay close attention to levels whenever the total resonance is above 50. If you use high resonance values (to produce a deep flange effect, for example) and the clip LEDs light while the Headroom LEDs are less than 0dB, try turning down the level of the effect that precedes the Chorus block.

Chorus

Chorus

This is a true stereo, multi-voice chorus. Use it to enrich guitars, keyboards, etc. It has Dual 2-tap modulators with cross resonance. The Pulse Width controls allow independent adjustment of the waveshape. (At 0, the sine wave becomes a sawtooth with a fast rise and slow fall.) The Depth controls provide adjustment of the chorus from 0-100%.

Mix	0-100%	Dry/Wet ratio
Level	Off, -89 to +6dB	Amount of effect in the processed signal
Rate1	0-50Hz or 1:24-24:1 cycles/beat	Left and right A rate
(Rate1 Units)		Selects frequency or cycles/beat
PW 1	0-100%	Left and right A pulse width
Dpth1*	0-100%	Left and right A depth
Rate2	0-50Hz or 1:24-24:1 cycles/beat	Left and right B rate
(Rate 2 Units)		Selects frequency or cycles/beat
PW 2	0-100%	Left and right B pulse width
Dpth2*	0-100%	Left and right B depth
Res 1	-100 to +100	Left to right resonance
Res 2	-100 to +100	Right to left resonance

* = Interpolated; () = Option of preceding parameter

Chorus Flanger (M) and Flanger (S)

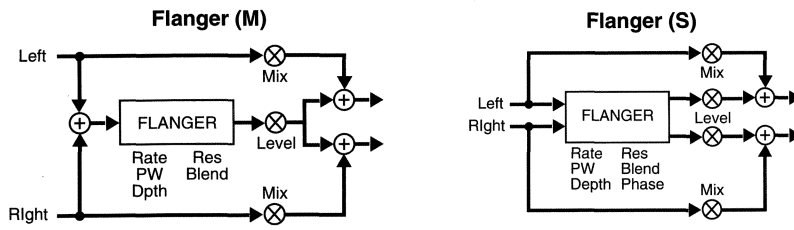

Mix	0-100%	Dry/Wet ratio
Level*	Off, -89 to +6dB	Amount of effect in the processed signal
Rate	0-50Hz or 1:24-24:1 cycles/beat	Flange rate or period ratio
(Rate Units)		Selects frequency or cycles/beat
PW	0-100%	Flange pulse width
Depth*	0-100%	Flange depth
Phase	0°-270°	In Flanger (S) sets the phase difference between the right and left flangers
Res	-100 to +100	Resonance
Blend	0-100%	Amount of fixed tap mixed with moving tap

Originally, flanging effects were created by simultaneously playing two identical programs on two tape recorders, then using hand pressure against the flange of the tape reels to slow down first one machine, then the other. The result was a series of changing phase cancellations and reinforcements, providing a comb filter and a characteristic swishing, tunneling and fading sound.

In the MPX 1, the Flanger effects are two-tap delays. The first tap is fixed, and the second sweeps past it. Mixing the two taps together creates a flanging effect. In **Flanger (M)**, the moving tap is swept with an internal LFO.

In the stereo version, **Flanger (S)**, the delays are modulated by two sine waves from the same LFO. The phase relation between the two waves is set by the Phase parameter.

480PrimeFlng FlangeSwp AB

Chorus Phaser

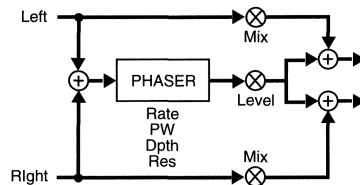

Mix	0-100%	Dry/Wet ratio
Level	Off, -89 to +6dB	Amount of effect in the processed signal
Rate	0-50Hz or 1:24-24:1 cycles/beat	Phaser rate or period ratio
(Rate Units)		Selects frequency or cycles/beat
PW	0-100%	Phaser pulse width
Depth*	0-100%	Phaser depth
Res	-100 to +100%	Amount of feedback from output of filters to inputs

The Phaser effect is a simulated Mutron phaser.

FazerEkoRvb Phased Place

* = Interpolated; () = Option of preceding parameter

Chorus Rotary Cab

This effect simulates a Leslie speaker with one pair of stereo mics on the rotating low-frequency drum, and another pair on the rotating high-frequency horn. Bal sets the relative mix of Drum and Horn mics. Width controls the stereo spread of both pairs of mics. Rate and Depth 1 control the speed and depth of the rotating low-frequency drum. Rate 2 and Depth 2 control the speed and depth of the rotating high-frequency horn. The preset, **Rotary Cab**, is set up so that A/B switches the speed from fast to slow. Different A and B rates are used to simulate the inertia of the mechanical system.

Rotary Cab

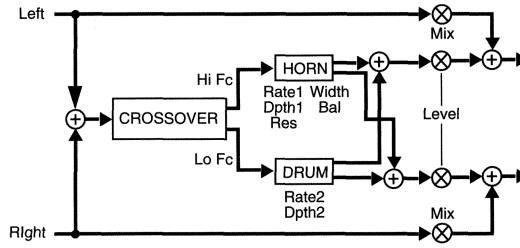

Mix	0-100%	Dry/Wet ratio
Level*	Off, -89 to +6dB	Amount of effect in the processed signal
Rate1	0-50Hz or 1:24-24:1 cycles/beat	Drum rate or period ratio
(Rate1 Units)		Selects frequency or cycles/beat of drum
Dpth1*	0-100%	Drum depth (tremolo)
Rate2	0-50Hz or 1:24-24:1 cycles/beat	Horn rate or period ratio
(Rate2 Units)		Selects frequency or cycles/beat of horn
Dpth2*	0-100%	Horn depth (tremolo)
Res	-100 to +100	Resonance
Width*	0-100%	Panning width for horn and drum
Bal	-50 to +50	Relative level of horn and drum

Chorus Aerosol

Aerosol is a true stereo chorus/flanger with dual rate, depth and resonance controls. It can produce very deep resonant flange sweeps, subtle multi-vibrato, stereo image enhancement and a wide variety of other chorus and flanger-like effects.

A pair of single-tap modulated delays is each modulated by a separate LFO. Pulse Width allows independent adjustment of left and right LFOs from full left to full right skew. (At 0, the sinewave becomes a sawtooth with a fast rise and slow fall.) Depth controls provide adjustment of modulated depth from 0-100%.

AeroFreez AB Aerosol

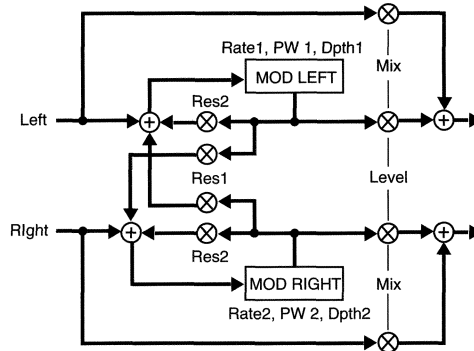

Mix	0-100%	Dry/Wet ratio
Level	Off, -89 to +6dB	Amount of effect in the processed signal
Rate1	0-50Hz or 1:24-24:1 cycles/beat	Left Mod rate or period ratio.
(Rate 1 Units)		Selects frequency or cycles/beat
PW 1	0-100%	Left Mod pulse width
Dpth1*	0-100%	Left Mod depth (tremolo)
Rate2	0-50Hz or 1:24-24:1 cycles/beat	Right Mod rate or period ratio.
(Rate 2 Units)		Selects frequency or cycles/beat
PW 2	0-100%	Right Mod pulse width
Dpth2*	0-100%	Right Mod depth (tremolo)
Res1	-100 to +100	Cross resonance
Res2	-100 to +100	Resonance

* = Interpolated; () = Option of preceding parameter

Chorus **Orbits**

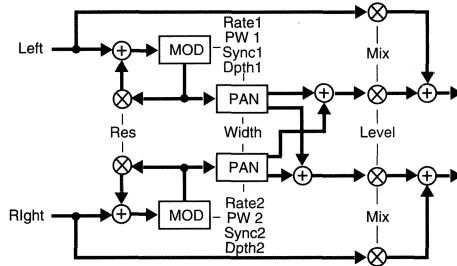

Mix	0-100%	Dry/Wet ratio
Level*	Off, -89 to +6dB	Amount of effect in the processed signal
Rate1	0-50Hz or 1:24-24:1 cycles/beat	Left Mod and Pan rate or period ratio
(Rate 1 Units)		Selects frequency or cycles/beat
PW 1	0-100%	Left Mod and Pan pulse width
Sync1	-120° to +120°	Phase difference between left LFO Mod and Pan
Dpth1*	0-100%	Left Mod and Pan depth
Rate2	0-50Hz or 1:24-24:1 cycles/beat	Right Mod and Pan rate or period ratio
(Rate 2 Units)		Selects frequency or cycles/beat
PW 2	0-100%	Right Mod and Pan pulse width
Sync2	-120° to +120°	Phase difference between right LFO Mod and Pan
Dpth2*	0-100%	Right Mod and Pan depth
Res	-100 to +100	Resonance
Width*	0-100%	Panning width

Orbits processes the left and right inputs independently with a pair of modulated delay/auto panners. This effect can be used to create spatial effects via a combination of Doppler and level panning.

In the Orbits effect, Pulse Width controls allow independent adjustment of left and right LFOs from full left to full right skew. (At 0, the sine wave becomes a sawtooth with a fast rise and slow fall.) Depth controls provide adjustment of Mod and Pan depth from 0-100%. Width allows adjustment of the panning depth from 0 (mono) to 100 (maximum stereo spread).

OD Rotary

* = Interpolated; () = Option of preceding parameter

Chorus Centrifuge1 and Centrifuge2

The Centrifuge effects have a pair of modulated left and right delays routed into a single auto panner. In these effects, mod and pan rate and depth (Rate1, Depth1) are modulated by an additional set of rate and depth controls (Rate2, Depth2). These can create unique chorus and flanger effects with complex, undulating modulation rhythms.

Circle Flange

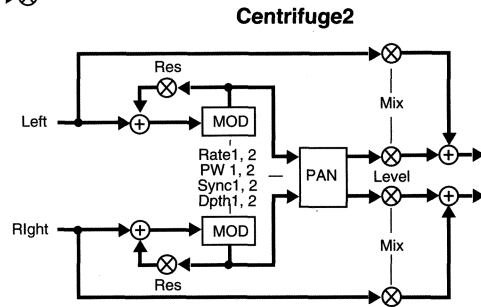
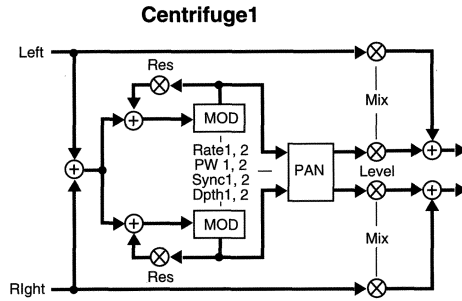

Mix	0-100%	Dry/Wet ratio
Level*	Off, -89 to +6dB	Amount of effect in the processed signal
Rate1	0-50Hz or 1:24-24:1 cycles/beat	Left Mod and Pan rate or period ratio
(Rate 1 Units)		Selects frequency or cycles/beat
PW 1	0-100%	Left Mod and Pan pulse width
Sync1	-120 to +120	Phase difference between left LFO Mod and Pan
Dpth1*	0-100%	Left Mod and Pan depth
Rate2	0-50Hz or 1:24-24:1 cycles/beat	Right Mod and Pan rate or period ratio
(Rate 2 Units)		Selects frequency or cycles/beat.
PW 2	0-100%	Right Mod and Pan pulse width
Sync2	-120 to +120	Phase difference between right LFO Mod and Pan
Dpth2*	0-100%	Right Mod and Pan depth
Res	-100 to +100	Resonance

* = Interpolated; () = Option of preceding parameter

Chorus **Comb 1 and Comb 2**

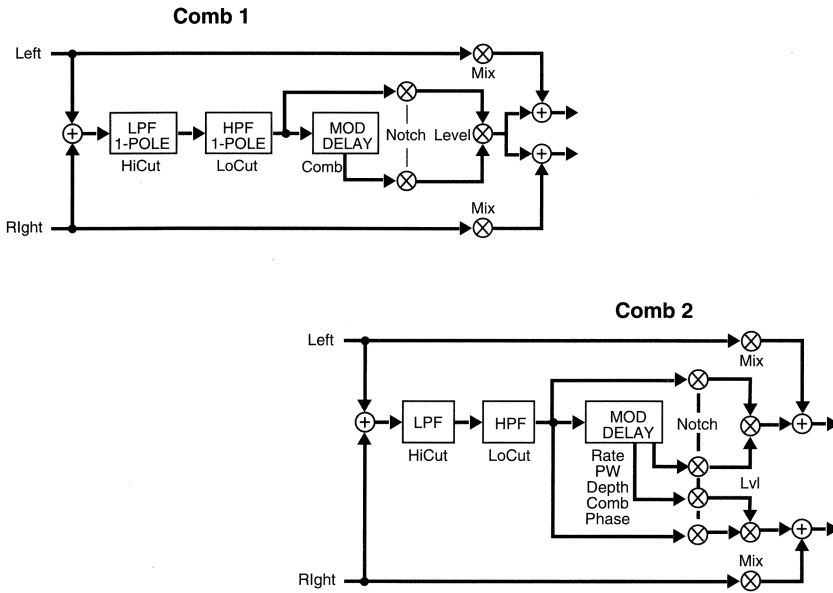

The Comb effects work by combining the original input signal with a micro-delayed version. The tiny delay difference between the two signals causes certain frequencies to be cancelled or reinforced when the two are combined. The result is a highly colored version of the original source. The coloration can be "tuned" with the Comb (Comb 1) or Depth (Comb 2). Low and High pass filters are included so you can limit the frequency band in which the combing occurs.

Comb 1 is a mono flanger with single-pole low and high cut filters. There are two ways to get the comb effect. The first is to set mix to 100% (wet), then set depth to 50 or -50. This essentially creates a band-limited signal (limited by LoCut and HiCut) which is then run through a flanger. You can also set mix= 50%, Lvl = 0dB, and Notch= ±100. In this case, the band-limiter is part of the flanger. In this version, the effect produces shallower notch depths outside the band-limit region.

Comb 2 is a dual mono flanger with a second tap, controlled by a single LFO with adjustable phase. The phase relation between the two waves can be adjusted between 0-270°.

Mix	0-100%	Dry/Wet ratio
Level	Off, -89 to +6dB	Amount of effect in the processed signal
LoCut	100-10000Hz	Corner frequency of the low cut filter
HiCut	100-10000Hz	Corner frequency of the high cut filter
Comb	0-100	A microdelay which positions the notch
Notch	-100 to +100	Increases the audibility of the notch
		Ratio of filter and delay output levels:
		Notch Filter Output Mod Delay Output
		-100 0% -100%
		-50 100% -100%
0 100% 0%		
50 100% 100%		
100 0% 100%		
Rate	0-50Hz or 1:24-24:1 cycles/beat	Mod rate or period ratio (Comb 2 only)
(Rate Units)		Selects frequency or cycles/beat (Comb 2 only)
PW	0-100%	Mod pulse width (Comb 2 only)
Depth*	0-100%	Mod depth (Comb 2 only)
Res	-100 to +100	Resonance (Comb 2 only)
Phase	0°-270°	Phase difference between the right and left Mod (Comb 2 only)

Comb Rubberate

* = Interpolated; () = Option of preceding parameter

EQ Effects

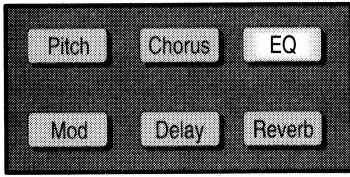

At its simplest, equalization is the process of cutting and boosting certain frequencies to make portions of program material more or less audible. This is generally accomplished by combining filters which affect a specific “band” of frequencies together with gain controls. The three types of filters commonly used to perform basic EQ functions are: High Cut, Low Cut and Bandpass/Notch.

High cut filters remove frequencies above a fixed level. As this allows frequencies below the threshold to pass through unchanged, high cut filters are also commonly referred to as “lowpass” filters.

Low cut filters, which remove frequencies below a fixed level and allow higher frequencies to pass through are also known as “highpass” filters.

Bandpass/Notch filters allow only a certain range of frequencies to pass through without attenuation. They are plotted as curves, with a peak (or dip in the case of notch filters) at the center frequency.

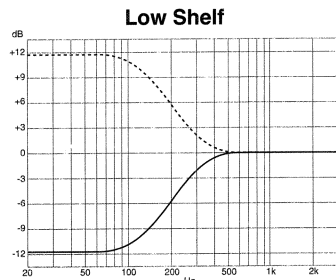
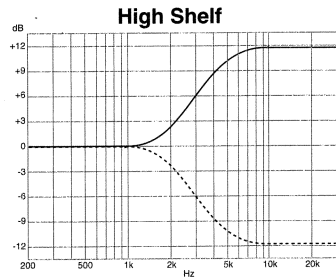
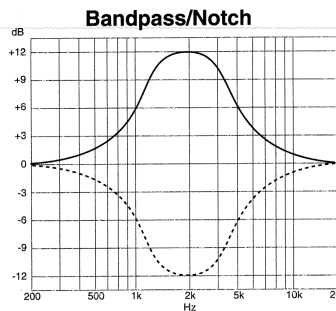
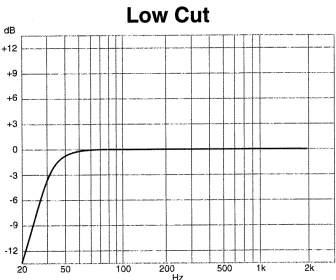
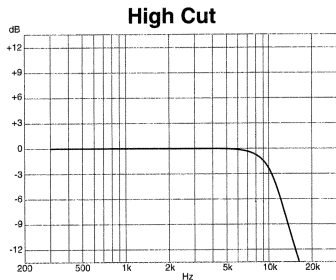

Shelf filters

When a specific frequency value is selected for cutting or boosting, and compensating gain controls are provided, a shelving filter is created, with gradual build up of the boost or cut to the selected frequency, followed by a leveling off beyond the selected frequency. When the effect of the filter is plotted, it resembles a shelf, with constant levels of boost or cut preceding and following the “knee” or “corner point” at the selected frequency.

A typical application of these filters uses 2-band equalization with two shelf filters, one low and one high, to provide bass and treble tone control. These two filters affect only the high and low frequency signals, leaving the center frequencies unaltered. Adding a third or fourth band of equalization in the form of midrange bandpass filters provides more control over those frequencies where hearing is most sensitive, and where most of the energy in music exists. (500Hz-4kHz). These midrange bands peak, or dip, at a center frequency which can be varied to provide much greater control over different aspects of the sound, allowing for bass or treble rolloff to decrease boominess, thicken sounds, reduce noise, or increase brightness.

Parametric EQ

Parametric equalizers provide boost and cut controls, sweepable center frequencies, and adjustment of “Q”, or the broadness or sharpness of the EQ curve — all of the parameters of equalization. This ability to broaden or narrow the peak at certain frequencies allows specific sounds to be accented or diminished with minimal effect on adjacent frequencies. As all equalization has potentially adverse side effects on program material, this ability to precisely adjust only specific frequencies has the advantage of minimizing the amount of EQ applied to program material. It also allows the creation of specific effects such as sharply narrowed EQ curves (notches) which are useful for feedback control or removal of specific noise artifacts.

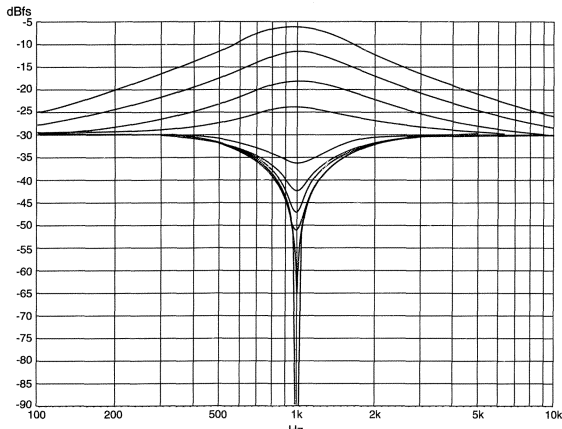

MPX 1 Parametric EQ: Gain

Fc=1000Hz Q=1.0 Gain=+24dB, +18dB, +12dB,
+6dB, 0dB, -6dB, -18dB,
-24dB, -36dB, -72dB

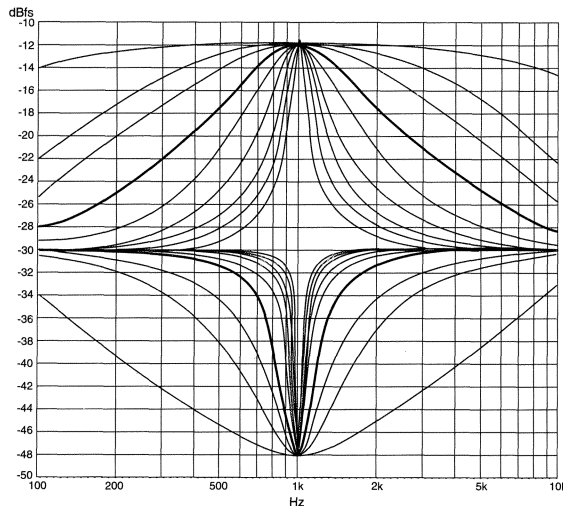

MPX 1 Parametric EQ: Q

Fc=1000Hz Gain=±18dB Q=0.1, 0.3, 0.5, 1.0, 2.0,
4.0, 6.0, 8.0, 10.0

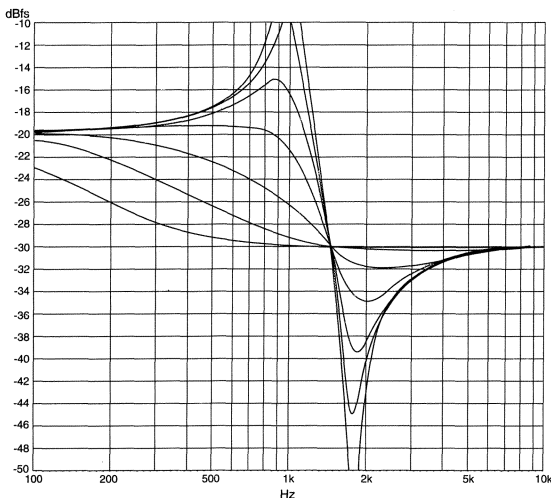

MPX 1 Parametric EQ: Shelf

Fc=1000Hz Gain=+10dB Q=0.1, 0.2, 0.5, 1.0, 2.0,
4.0, 10.0

EQ Tips (for tweakers only)

About “Q”

Q is a measure of the sharpness of an EQ curve. The larger the Q value, the sharper the curve. In some situations it is convenient to think of Q in terms of bandwidth in octaves. Some examples:

Q	Bandwidth
0.1	approximately 6 1/2 octaves
0.4	approximately 3 octaves
0.7	approximately 2 octaves
1.4	approximately 1 octave
2.9	approximately 1/2 octave
4.3	approximately 1/3 octave
5.8	approximately 1/4 octave
7.2	approximately 1/5 octave
8.7	approximately 1/6 octave
10.0	approximately 1/7 octave

There are mathematical limits to how small the Q value can be in MPX 1 EQ effects. For any given frequency, the Q must be greater or equal to the frequency divided by 10,000. For example if the frequency is 5kHz, the actual Q value won't go below 0.5. (The MPX 1 will allow you to dial in lower values, but the actual Q will not go below the mathematical limit.)

For most shelving applications, Q should be set very low (Around 0.2). As you increase the Q, the filter becomes peaky, but a dip also develops just outside the passband. For many applications, a bandpass or band cut filter with a moderate Q and a low (or high) center freq will prove sonically superior to the shelving filter.

Making a Low Pass Filter

To make a two-pole low-pass filter, start with a high shelf, and set Gain to -72 (effectively off). This creates a low pass filter with a corner frequency at Fc. A Q of 0.7 makes a flat passband. Higher Q settings produce a peak at Fc, and lower Q settings produce a droop.

EQ 1-Band (M), 2-Band (M), 3-Band (M) and 4-Band (M)

The 1-Band (M) effect provides a single band of double-precision parametric EQ.

2-Band (M), 3-Band (M) and 4-Band (M) have two, three and four bands, respectively, of double-precision parametric EQ. Each effect has adjustable center frequency, Q, boost/cut and filter type (low shelf, band, high shelf).

Call Waiting Vocal EQ

Mix	0-100%	Dry/Wet ratio
Level	Off, -89 to +6dB	Amount of effect in the processed signal
Gain (1-4)	-72 to +24dB	Boost/cut gain of filter(s)
Fc (1-4)	20-20000Hz	Center or corner frequency of filter(s)
Q (1-4)	0.1-10.0	Q of filter(s)
Mode (1-4)	LShlf, Band, HShlf	Determines EQ type(s)

EQ 1-Band (S), and 2-Band (S)

1-Band (S) has two bands of double-precision parametric EQ, one on each channel. 2-Band (S) has four bands of double-precision parametric EQ, two on each channel.

The two channels share the filter controls. Center frequency, Q, boost/cut and filter type (low shelf, band, high shelf) are adjustable.

Digital EQ (S) Piano Hall

Mix	0-100%	Dry/Wet ratio
Level	Off, -89 to +6dB	Amount of effect in the processed signal
Gain (1-2)	-72 to +24dB	Boost/cut gain of filter(s)
Fc (1-2)	20-20000Hz	Center or corner frequency of filter(s)
Q (1-2)	0.1-10.0	Q of filter(s)
Mode (1-2)	LShlf, Band, HShlf	Determines EQ type(s)

EQ 1-Band (D) and 2-Band (D)

1-Band (D) has two bands of double-precision parametric EQ, one on each channel. 2-Band (D) has four bands of double-precision parametric EQ, two on each channel.

Center frequency, Q, boost/cut and filter type (low shelf, band, high shelf) are adjustable.

Dual 2-Band L=2BndR=Chmb

Mix	0-100%	Dry/Wet ratio
Level	Off, -89 to +6dB	Amount of effect in the processed signal
G-L, G-L1, G-L2	-72 to +24dB	Boost/cut gain of left filter(s)
Fc-L, Fc-L1, Fc-L2	20-20000Hz	Center or corner frequency of left filter(s)
Q-L, Q-L1, Q-L2	0.1-10.0	Q of left filter(s)
M-L, M-L1, M-L2	LShlf, Band, HShlf	Determines EQ type(s)
G-R, G-R1, G-R2	-72 to +24dB	Boost/cut gain of right filter(s)
Fc-R, Fc-R1, Fc-R2	20-20000Hz	Center or corner frequency of right filter(s)
Q-R, Q-R1, Q-R2	0.1-10.0	Q of right filter(s)
M-R, M-R1, M-R2	LShlf, Band, HShlf	Determines EQ type(s)

* = Interpolated; () = Option of preceding parameter

EQ SweepFilter

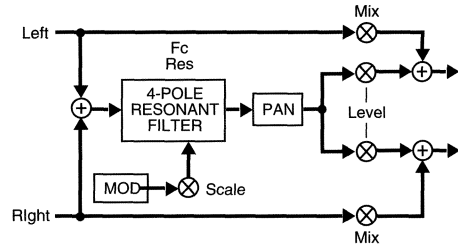

Mix	0-100%	Dry/Wet ratio
Level*	Off, -89 to +6dB	Amount of effect in the processed signal
Fc*	20-20000Hz	Corner frequency offset of filter
FRes*	1-100	Filter resonance: 7=a maximally flat filter
Mod*	20-20000Hz	added to corner frequency offset to produce corner frequency
Scale*	-100 to +100%	scales Mod
Pan*	50L to C to 50R	Left/right pan control

SweepFilter simulates a Moog-type resonant low-pass filter. Cutoff frequency and output level are interpolated, and can be swept. The performance of this filter is high enough that it can be used as a lowpass filter for hiss reduction.

The parameters were designed to allow synthesizer-like control of the filter. For example: Use FC like the manual “cutoff” knob of an analog synth – set it to the filter frequency desired when all modulation sources are at minimum.

Use Mod as the patch destination for as many as five modulation sources (LFO, ADR, Env, LastNote, S/H. etc.).

Use Scale as a master depth control for all modulation sources.

EkoSweepFiltr SynthChmbr

EQ Wah

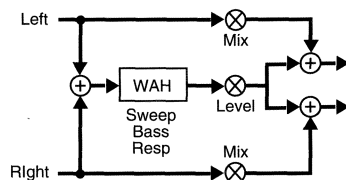

Mix	0-100%	Dry/Wet ratio
Level*	Off, -89 to +6dB	Amount of effect in the processed signal
Sweep*	0-100	Wah center frequency
(Type)	C, V	C=Crybaby, V=Vox
Bass	0-100	Adds a low frequency boost to the wah
Resp	0-100	Responsiveness to changes in Sweep

Wah is a mono wah filter modelled after two classic wah-wah pedals. With Sweep selected, press **Options** to select **Model C** (CryBaby) or **Model V** (Vox). These models capture both the characteristic signature and non-linear pedal response of the original pedals. The Bass control allows you to change the wah from a band-pass type effect to a low-pass type effect by progressively adding more low end into the effect. (Try it with bass and keyboards.) Resp controls how quickly the wah responds to changes of Sweep. (100 is very fast, 0 is very, very slow).

To make a Mutron-like envelope filter, patch sweep to Env1 or Env2. Use Resp to control the effect’s responsiveness to changing dynamics.

To make an Auto Wah effect, try patching Sweep to an LFO sine or triangle wave.

AutoWah Chrs Wah Pedal

* = Interpolated; () = Option of preceding parameter

EQ Fc Splitter

The Fc Splitter effect splits a mono input into a low-passed output on the left channel and a high-passed output on the right, with independent control of the corner frequencies of both filters. If the corner frequencies are the same, and the balance is set to 0, the frequency response will be flat when the two outputs are summed. Bal controls the relative level of left and right outputs. When Bal=0, the left and right outputs are not attenuated. Negative values attenuate the right output (high). Positive values attenuate the left (low).

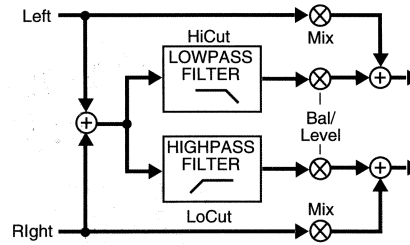

Mix	0-100%	Dry/Wet ratio
Level*	Off, -89 to +6dB	Amount of effect in the processed signal
LoCut	100-10000Hz	Corner frequency for the low cut (highpass)band
HiCut	100-10000Hz	Corner frequency for the high cut (lowpass) band
Bal*	-50 to +50	Relative level of the low and high band

OpenTheDoor

EQ Crossover

The Crossover effect is similar to Fc Splitter, but with only one crossover frequency, shared by low and high. In this effect, Level and Bal are not interpolated.

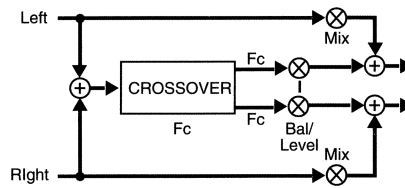

Mix	0-100%	Dry/Wet ratio
Level	Off, -89 to +6dB	Amount of effect in the processed signal
Fc	100-10000Hz	Crossover frequency
Bal	-50 to +50	Relative level of the low and high band

Fazer Tremolo OD Rotary

* = Interpolated; () = Option of preceding parameter

The Tone effects allow you to create a unique set of EQs to make simple tone adjustments.

The 2-Tone effects split the signal into two bands, one low and one high, with the controls to create low or high shelving filters. Gain1 cuts or boosts all of the frequencies below the frequency selected by Fc and Gain 2 cuts or boosts all frequencies above this point, creating a basic bass/treble control.

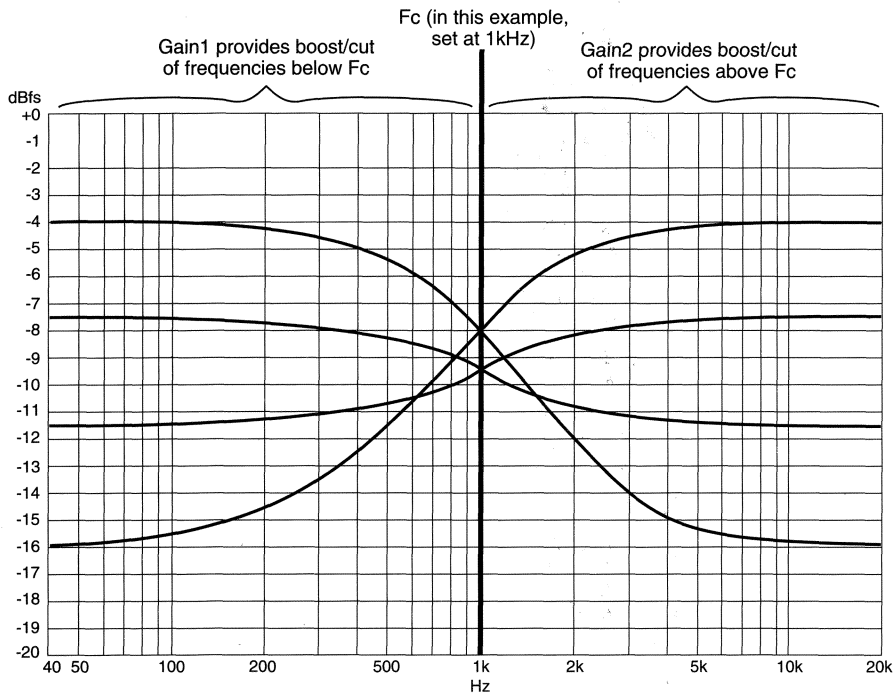

The 2-Tone and 3-Tone Effects

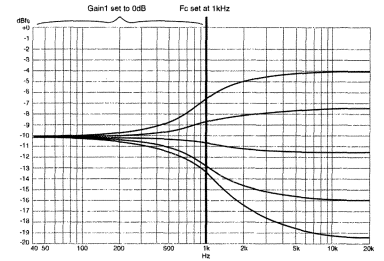

Setting Gain 1 to 0dB creates a simple treble control

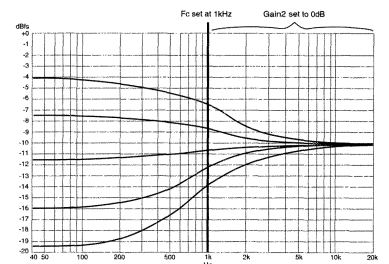

Setting Gain 2 to 0dB creates a simple bass control

EQ 2-Tone (M) , 2-Tone (S) and 2-Tone (D)

2-Tone (M)

2-Tone (S)

2-Tone (D)

Mix	0-100%	Dry/Wet ratio
Level	Off, -89 to +6dB	Amount of effect in the processed signal
Fc, FcL, FcR	100-10000Hz	Corner frequency of both low and high band(s)
Gain1, G-L1, G-L2	-90 to +6dB	Level of low band(s) (frequencies below Fc or FcL)
Gain2, G-R 1, G-R2	-90 to +6dB	Level of high band(s) (frequencies above Fc or FcR)

The **2-Tone (M)** effect splits the signal into low and high bands with independent adjustment of low and high levels, as well as the split frequency to create low and/or high shelving filters.

2-Tone (S) is a stereo version of **2-Tone (M)**. **2-Tone (D)** is a dual version.

Rock Organ Sweet+Wet

* = Interpolated; () = Option of preceding parameter

The 3-Tone effects have two selectable frequency selectors (Fc1 and Fc2) which split the signal into three bands controlled by Gain1, Gain2 and Gain3. The diagram below shows a few of the infinite variety of EQ curves which can be obtained from the 3-Tone effects.

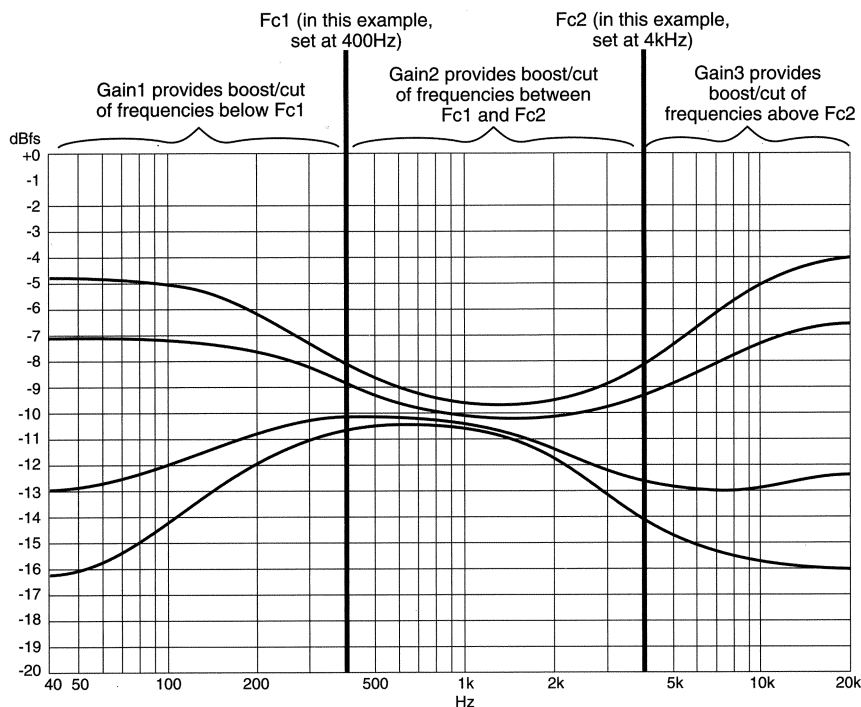

EQ 3-Tone (M), 3-Tone (S) and 3-Tone (D)

The **3-Tone (M)** effect splits the signal into low, mid, and high bands, and allows the user to adjust the three levels, as well as the two split frequencies to create both low and high shelving filters in a single effect. Setting the frequencies to the same value and the mid and high levels to Off creates a 4-pole low-pass filter.

3-Tone (S) is a stereo version of **3-Tone (M)**. **3-Tone (D)** is a dual version.

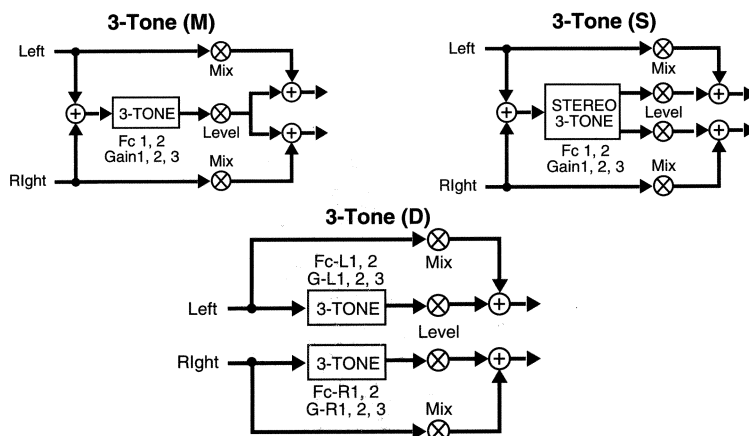

3-Tone TV in Room

Mix	0-100%	Dry/Wet ratio
Level	Off, -89 to +6dB	Amount of effect in the processed signal
Fc 1, Fc-L1, Fc-L2	100-10000Hz	Corner frequency of low band
Fc 2, Fc-R1, Fc-R2	100-10000Hz	Corner frequency of high band
Gain1, GL-1, GR-1	-90 to +6dB	Level of low band(s) (frequencies below Fc1, Fc-L1 or Fc-L2)
Gain2, GL-2, GR-2	-90 to +6dB	Level of mid band(s) (frequencies between Fc1 and 2)
Gain3, GL-3, GR-3	-90 to +6dB	Level of high band(s) (frequencies above Fc2, Fc-R1 or Fc-R2)

* = Interpolated; () = Option of preceding parameter

The Mod effects are a collection of pan, gain, and volume processors that can be modulated with built-in controllers or with any MPX 1 patch source.

With the exception of Overdrive, all Mod effects require relatively small amounts of processing resources and can therefore be used in combination with many other effects.

Mod Effects

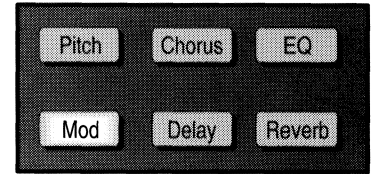

Mod **Panner**

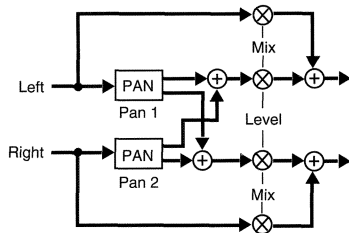

The Panner effect has the left input panned to outputs with Pan 1, right input with Pan 2. Because all the parameters of this effect are interpolated, this can be used to add interpolated outputs to effects which have non-interpolated output levels.

Mix*	0-100%	Dry/Wet ratio
Level*	Off, -89 to +6dB	Amount of effect in the processed signal
Pan 1*	50L to C to 50R	Left input panner
Pan 2*	50L to C to 50R	Right input panner

Random Pan

Mod **Auto Pan**

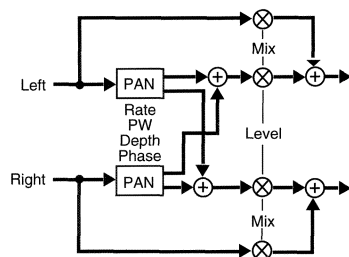

Auto Pan is a version of Panner with the pans controlled by a local LFO. The left input is panned by the LFO's sine output. The right input is panned by the cosine output, which is offset by 0°, 90°, 180° or 270° by the Phase parameter.

Mix*	0-100%	Dry/Wet ratio
Level*	Off, -89 to +6dB	Amount of effect in the processed signal
Rate	0-50Hz or 1:24-24:1 cycles/beat	Pan rate or period ratio
(Rate Units)		Selects frequency or cycles/beat
PW	0-100%	Pan pulse width
Depth*	0-100%	Pan depth
Phase	0°-270°	Phase difference between right and left pan

Stereo Spin **Auto Pan BPM**

* = Interpolated; () = Option of preceding parameter

Mod Tremolo (M) and Tremolo (S)

In Tremolo (M), the left and right inputs are mixed together, then a local sinewave generator modulates the volume.

In Tremolo (S) the left input is modulated by a local sinewave generator before going to the left output. The right input is modulated by sin, cos, -sin, or -cos, depending on the Phase parameter.

These are the smallest mono and stereo effects with interpolated output level controls. You can use them (with the tremolo turned off) to add smooth output level control to a stereo effect that doesn't have output level interpolation.

Vintage Trem Dyna Tremolo

Tremolo (M)

Tremolo (S)

Mix*	0-100%	Dry/Wet ratio
Level*	Off, -89 to +6dB	Amount of effect in the processed signal
Rate	0-50Hz 1:24-24:1 cycles/beat	Tremolo rate or period ratio
(Rate Units)		Selects frequency or cycles/beat
PW	0-100%	Tremolo pulse width
Depth*	0-100%	Tremolo depth
Phase	0°-270°	In Tremolo (S), controls the phase difference between the right and left tremolo

Mod Overdrive

Overdrive is a simple gain effect that produces non-linear distortion as the Drive control is turned up. This effect is useful for such things as simulating the sound of distorted radios and televisions, or adding some "edge" to other effects, etc. While not intended to be used as a full-blown guitar amp simulator, combinations of Overdrive and EQ or Comb effects can produce some very useful tone effects.

Car Radio Rock Organ

Mix	0-100%	Dry/Wet ratio
Level*	Off, -89 to +6dB	Amount of effect in the processed signal
Drive	0-100	Distortion control

* = Interpolated; () = Option of preceding parameter

Mod Volume (M), Volume (S) and Volume (D)

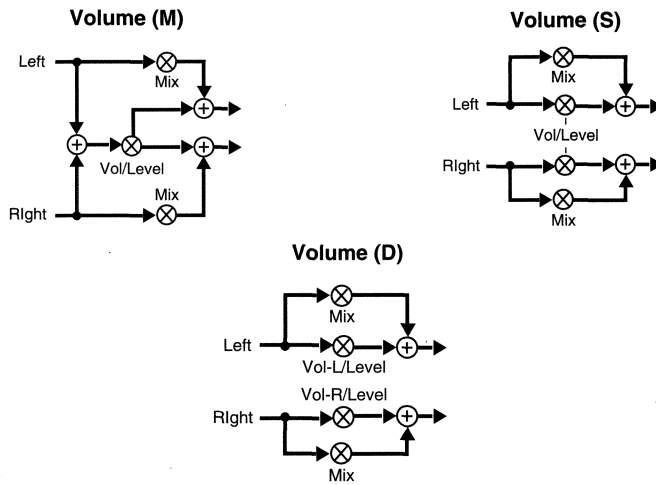

Mix	0-100%	Dry/Wet ratio
Level*	Off, -89 to +6dB	Amount of effect in the processed signal
Vol*	0-100%	Amount of effect in the processed signal

The Volume effects are included here for convenience when constructing programs that don't use Modulation effects.

These effects are simple, but have many applications. Place them in front of, or behind, other effect blocks to provide smooth level control through a 95dB range. You can use them for dynamic input or output control, EQ input trim (helpful when adding large amounts of gain with an EQ effect), stereo to mono mixer, cross fade controls, volume pedal, etc.

In **Volume(M)** the left and right inputs are mixed together, then sent to both outputs through a volume control.

In **Volume (S)** the left and right inputs are sent through a ganged pair of volume controls.

In **Volume (D)** the left and right inputs are sent through independent volume controls.

ChrsRvbMorph Volume Pedal

* = Interpolated; () = Option of preceding parameter

Delay Effects

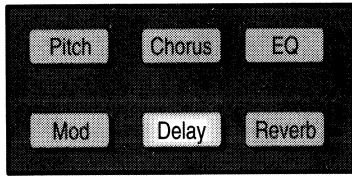

The Delay effects include delay, echo, looping and ducking effects. Delays are high quality digital delays. Echoes are similar to delays, but low-pass filters have been added to simulate the high-frequency rolloff that occurs naturally in acoustic echoes and in echoes created with analog tape.

All MPX 1 Delay effects allow you to choose how delay times will be displayed. Select any Time parameter and press **Options**. The following choices are available for each Time parameter:

- ms: time is displayed as milliseconds (delay time is fixed)
- feet: time is displayed as feet – the equivalent distance from a sound source required to produce the delay (delay time is fixed)
- meters: time is displayed as meters – the equivalent distance from a sound source required to produce the delay (delay time is fixed)
- echoes/beat: time is displayed as a rhythmic ratio of echoes per beat (delay time varies with Tempo and can be changed at any time by pressing TAP twice.)
- TAP ms: time is displayed as milliseconds (new delay value can be “tapped in” when this Time value is displayed for editing).

Another feature shared by all MPX 1 Delay effects is Fbk Insert. This option of the feedback parameter allows you to route the outputs of another effect block to the delay’s feedback input. If the other block is after the delay block, Fbk Insert will place it inside the delay/echo feedback loop. This powerful feature is the key to obtaining many classic effects.

Delay Delay (M), Delay (S) and Delay (D)

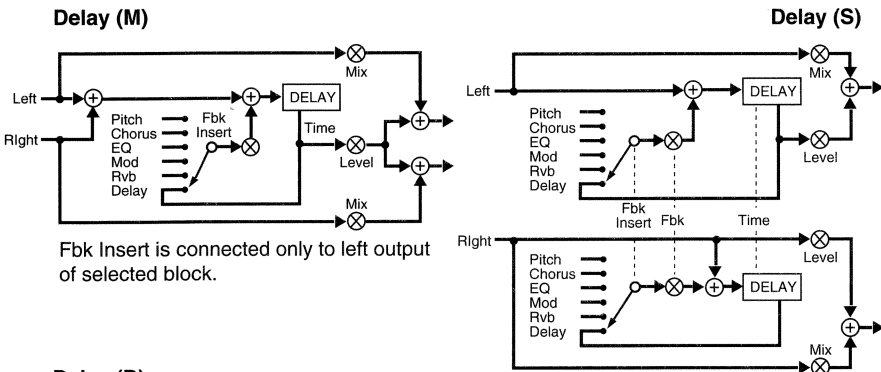

Fbk Insert is connected only to left output of selected block.

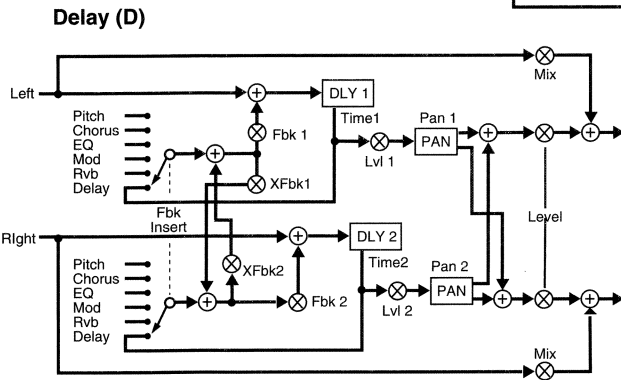

Delay (M) is a simple mono delay with feedback.

Delay (S) is a simple stereo delay with feedback.

Delay (D) is a dual delay with feedback, crossfeedback, independent output level adjusts, and panners.

Detune+Dlys Tap Delay

Mix	0-100%	Dry/Wet ratio
Level	Off, -89 to +6dB	Amount of effect in the processed signal
Time	0-2000ms (M) 1:24-24:1echo/beat, 0-2260 ft, 0-688 M	Delay time (in stereo and dual versions, 0-1000ms, 0-1130ft, 0-344 M)
(Time Units)		Selects ms, note, feet, meters, or Tap ms
Lvl 1*	Off, -95 to 0dB	In Delay (D), controls left delay output level
Lvl 2*	Off, -95 to 0dB	In Delay (D), controls right delay output level
Pan 1*	50L to C to 50R	In Delay (D), controls left delay output panner
Pan 2*	50L to C to 50R	In Delay (D), controls right delay output panner
Fbk 1	-100 to +100%	Left feedback level
(Fbk insert)	Pitch, Chorus, EQ, Mod, Reverb, Delay	The outputs of the selected source are scaled by Fbk
Fbk 2	-100 to +100%	Right feedback level
XFbk1	-100 to +100%	In Delay (D), controls level from left feedback source to right delay in
XFbk2	-100 to +100%	In Delay (D), controls level from right feedback source to left delay in

* = Interpolated; () = Option of preceding parameter

Delay Echo (M), Echo (S) and Echo (D)

The Echo effects are similar to the Delay effects, except the feedback inputs are sent through 1-pole low-pass filters.

Damp provides control over the cutoff frequency of the filter. (Increasing Damp lowers cutoff frequency.)

Guitar Solo Tape Echo

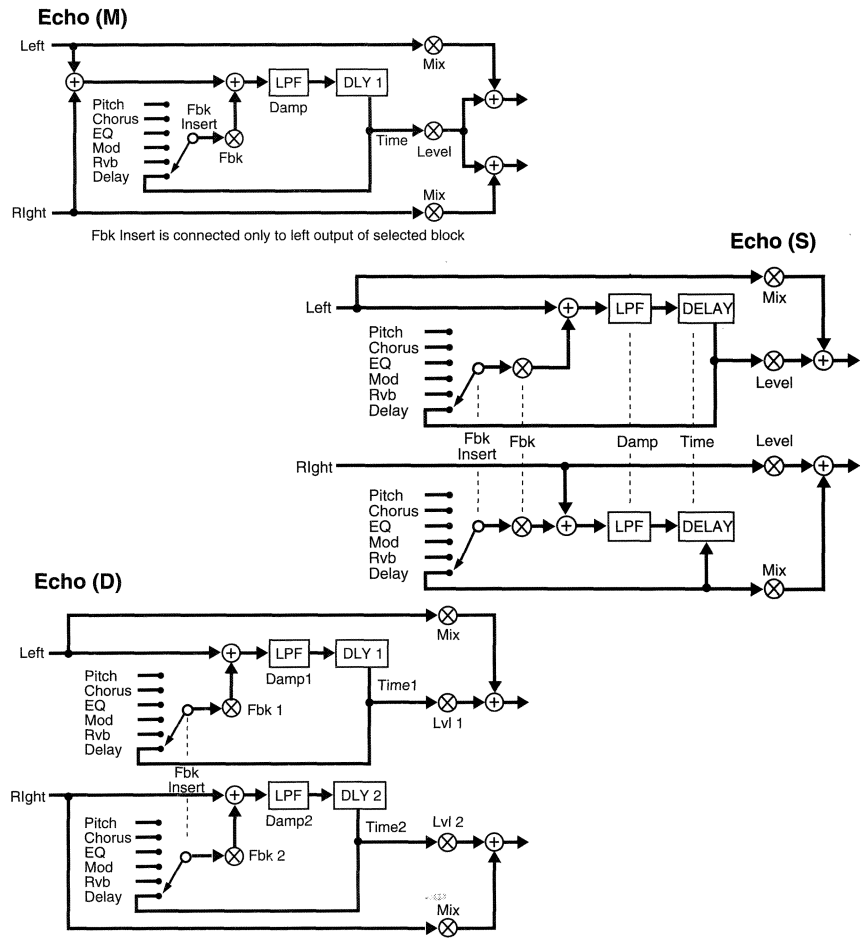

Mix	0-100%	Dry/Wet ratio
Level	Off, -89 to +6dB	Amount of effect in the processed signal
Time	0-2000ms 1:24-24:1echo/beat, 0-2260 ft, 0-688 M	Delay time in mono version
(Time Units)		Selects ms, note, feet, meters, or Tap ms
Time1	0-1000ms 1:24-24:1echo/beat, 0-1130 ft, 0-344 M	Left delay time
(Time1 Units)		Selects ms, note, feet, meters, or Tap ms
Time2	0-1000ms, 1:24-24:1echo/beat 0-1130 ft, 0-344 M	Right delay time
(Time2 Units)		Selects ms, note, feet, meters, or Tap ms
Lvl 1*	Off, -95 to 0dB	In Echo (D) controls left delay output level
Lvl 2*	Off, -95 to 0dB	In Echo (D) controls right delay output level
Fbk 1	-100 to +100%	Left feedback level
(Fbk insert)	Pitch, Chorus, EQ, Mod, Reverb, Delay	The outputs of the selected source are scaled by Fbk
Fbk 2	-100 to +100%	Right feedback level
Damp1	0 to +100%	Cutoff frequency of low-pass filter in left feedback path
Damp2	0 to +100%	Cutoff frequency of low-pass filter in right feedback path

* = Interpolated; () = Option of preceding parameter

Delay **Looper**

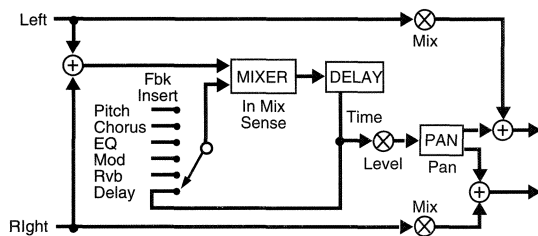

Mix	0-100%	Dry/Wet ratio
Level	Off, -89 to +6dB	Amount of effect in the processed signal
Time	0-2000ms 1:24-24:1echo/beat 0-2260 ft, 0-688 M	Delay time
(Time Units)		Selects ms, note, feet, meters, or Tap ms
InMix	0-100%	Ratio of input to feedback going into the delay
(Fbk insert)	Pitch, Chorus, EQ, Mod, Reverb, Delay	The left output of the selected source is scaled by Fbk
Sense	0-100	Sensitivity of InMix to input amplitude
Pan	50L to C to 50R	Output panner
Rls	0-100	Envelope release time constant
Atk	0-100	Envelope attack time constant

In the Looper effect InMix controls the ratio of input to feedback into the delay. This parameter is ducked by the input level, so that louder signals route the input signal into the delay, and softer signals route the feedback signal into the delay. When Sense is at 0, no ducking will occur. At 100 the input will be ducked by even the lowest input levels.

A/B Freeze **Capture EQ**

Delay **Ducker**

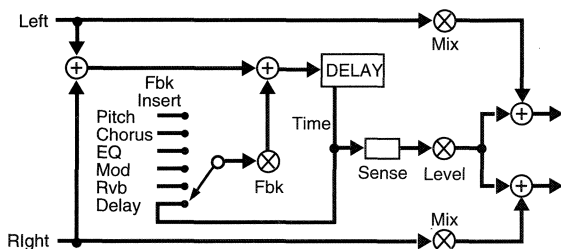

Mix	0-100%	Dry/Wet ratio
Level	Off, -89 to +6dB	Amount of effect in the processed signal
Time	0-2000ms 1:24-24:1echo/beat 0-2260 ft, 0-688 M	Delay time
(Time Units)		Selects ms, note, feet, meters, or Tap ms
Fbk	-100 to +100%	Feedback level
(Fbk insert)	Pitch, Chorus, EQ, Mod, Reverb, Delay	The left output of the selected source is scaled by Fbk
Sense	0-100	Amount of ducking
Rls	0-100	Envelope release time constant

Similar to Looper, with the wet output getting quieter as the input gets louder. When Sense is at 0, no ducking will occur. At 100 the input will be ducked by even the lowest input levels.

DuckedDelay

* = Interpolated; () = Option of preceding parameter

Reverb Effects

The MPX 1 Reverb effects provide a full suite of reverberation and ambience algorithms. All of the reverbs are true stereo in that different processing is applied to the left and right input signals. Dedicated processing resources are allocated to the reverb effects so that you can always load any reverb into any program, regardless of what other effects are loaded.

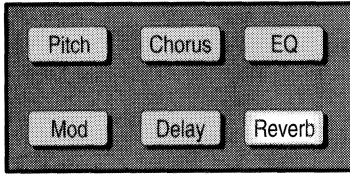

Reverb Chamber

The Chamber effect produces an even, relatively dimensionless reverberation, with little change in color as the sound decays. The initial diffusion is similar to the Hall effect, but the sense of space and size is much less obvious. This characteristic, along with the low color of the decay tail makes Chamber useful on a wide range of material. It is especially useful on spoken voice, giving a noticeable increase in loudness with very low color.

Chamber 4PA Jazz Chamber

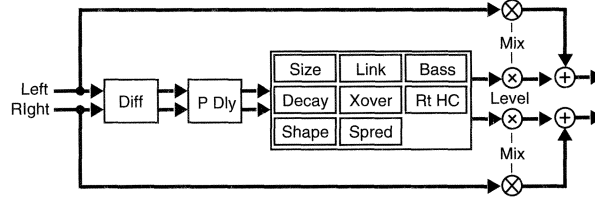

Mix	0-100%	Dry/Wet ratio
Level	Off, -89 to +6dB	Amount of effect in the processed signal
Size	4.0-35 meters	Length of Chamber
Link	Off, On	Scales Decay and Spred with Size
Diff	0-100%	Increase of initial echo density over time
P Dly	0-250ms	Delay inserted before the onset of reverberation
Bass	0.2-4.0x	Reverb time for low frequency signals
Decay	0.07-65.4s	Reverb time for mid frequency signals
Xover	30Hz to 19.5kHz, Off	Frequency of transition from Decay to Bass
Rt HC	525Hz-21.2kHz	High frequency content of Decay
Shape	0-255	Contour of the reverberation envelope
Spred	0-255	Sustain of reverberation after initial build up

Reverb Hall

The Hall effect emulates a real concert hall. The reverberation is very clean, and designed to remain behind the direct sound — adding ambience, but leaving the source unchanged. This effect has a relatively low initial density which builds up gradually over time.

Hall 4PA Concert Hall

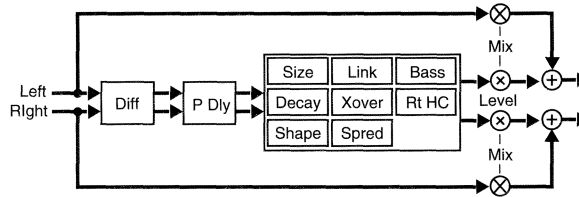

Mix	0-100%	Dry/Wet ratio
Level	Off, -89 to +6dB	Amount of effect in the processed signal
Size	20-76 meters	Length of Hall
Link	Off, On	Scales Decay and Spred with Size
Diff	0-100%	Increase of initial echo density over time
P Dly	0-250ms	Delay inserted before the onset of reverberation
Bass	0.2-4.0x	Reverb time for low frequency signals
Decay	0.12-65.4s	Length of the reverb tail
Xover	30Hz to 19.5kHz, Off	Frequency of transition from Decay to Bass
Rt HC	525Hz-21.2kHz	High frequency content of Decay
Shape	0-255	Contour of the reverberation envelope
Spred	0-255	Sustain of reverberation after initial build up

* = Interpolated; () = Option of preceding parameter

Reverb **Plate**

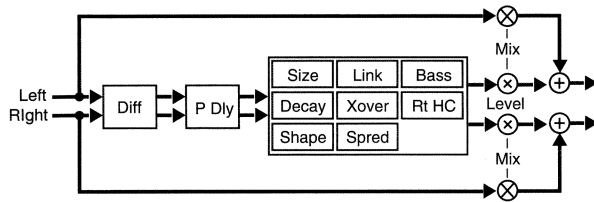

Mix	0-100%	Dry/Wet ratio
Level	Off, -89 to +6dB	Amount of effect in the processed signal
Size	4.0-76.0 meters	Length of room
Link	Off, On	Scales Decay and Spred with Size
Diff	0-100%	Increase of initial echo density over time
P Dly	0-250ms	Delay inserted before the onset of reverberation
Bass	0.2-4.0x	Reverb time for low frequency signals
Decay	0.07-65.4s	Length of the reverb tail
Xover	30Hz to 19.5kHz, Off	Frequency of transition from Decay to Bass
Rt HC	525Hz-21.2kHz	High frequency content of Decay
Shape	0-255	Contour of the reverberation envelope
Spred	0-255	Sustain of reverberation after initial build up

Plate effects were originally generated by large, thin sheets of metal suspended upright under tension on springs. Transducers attached to the plate would transmit a signal which would, in turn, vibrate the plate. Because the plate provided a denser medium than air, sounds broadcast through it would seem to be occurring in a large open space.

The Plate effect synthesizes the sound of metal plates, with high initial diffusion and a relatively bright, colored sound. This effect is designed to be heard as part of the music, mellowing and thickening the initial sound. It is a popular choice for enhancing popular music, particularly percussion.

Plate 4PA **Vocal Plate**

Reverb **Gate**

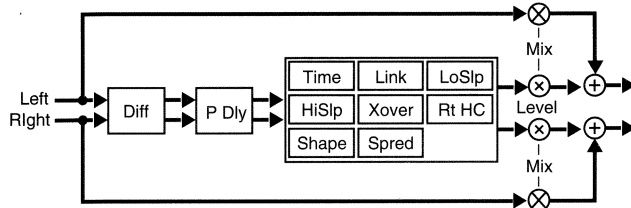

Mix	0-100%	Dry/Wet ratio
Level	Off, -89 to +6dB	Amount of effect in the processed signal
Time	140-700ms	Reverb time for mid and low frequency signals
Link	Off, On	Scales Spred with Size
Diff	0-100%	Increase of initial echo density over time
P Dly	0-250ms	Delay inserted before the onset of reverberation
LoSlp	-16 to +16	Determines low frequency envelope shape
HiSlp	-16 to +16	Determines mid and high frequency envelope shape
Xover	30Hz to 19.5kHz, Off	Frequency of transition from LoSlp to Slope
Rt HC	525Hz-21.2kHz	High frequency content of Slope
Shape	0-255	Contour of the reverberation envelope
Spred	0-255	Sustain of reverberation after initial build up

Gate is a reverb effect with a fairly constant sound and no decay until the reverb is cut off abruptly. This effect works well on percussion—particularly on snare and toms, but be sure to experiment with other sound sources as well.

The Mix, P Dly and Rt HC parameters are very important in this effect, allowing you to create anything from an enhancement or subtle thickening, to a solid wall of reverb.

Gate 4PA **Reverse Rvb**
Snare Gate

* = Interpolated; () = Option of preceding parameter

Reverb **Ambience**

The Ambience effect gives warmth, spaciousness and depth to a performance without coloring the direct sound, and is commonly used to add a room sound to recorded music or speech. The effect simulates reflections from room surfaces, with random reflections, a gradual decay of overall level, and a gradual narrowing of the bandwidth. DTime settings can be varied to create larger or smaller spaces while variations of D Lvl and Rt HC correspond to the hardness of the imaginary reflecting surfaces and the effects of air absorption on the high end of the sonic spectrum.

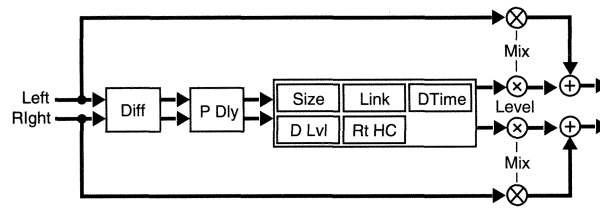

Mix	0-100%	Dry/Wet ratio
Level	Off, -89 to +6dB	Amount of effect in the processed signal
Size	4.0-76 meters	Length of room
Link	Off, On	Scales DTime with Size
Diff	0-100%	Increase of initial echo density over time
P Dly	0-250ms	Delay inserted before the onset of reverberation
DTime	0.07-65.4s	Length of the ambience tail
D Lvl	Off, -48dB to Full	Level of the ambience tail
Rt HC	0.5-21.2kHz	High frequency content of DTime

Ambi 4PA **Miked Cab EQ**
TV in Room

* = Interpolated; () = Option of preceding parameter

This chapter describes all of the MPX 1 internal controllers. Examples of presets which make use of a controller are noted to the side of each description. The controls for making individual adjustments and assignments to the controllers are available in the **Edit** menu and are described in Chapter 3: *Editing*.

The Knob controller allows you to define your own custom patch controller. Once defined, you can place it in the Soft Row with its own label. You can even define the upper and lower limits of the control. Use **Knob** when you want to manually adjust the values of more than one parameter simultaneously, or when you want to limit the range of control over a single parameter.

Knob (Soft knob assignment for front panel parameter control)

Parameter	Range	Description
Value	0-127	initial setting
Low	0-127	Low point of range
High	0-127	High point of range
Name	9 characters	Custom name

In general an LFO is a source whose output cycles constantly between 0, 127 and 0. Each LFO produces four simultaneous output waveforms: Sine, Cosine, Triangle and Pulse. Rate controls how fast the output cycles — you can set the rate as either a frequency (such as 3Hz) or as a rhythmic value (such as 2:3 cycles per beat). A Depth parameter scales the output range. Several additional parameters make the MPX 1 LFOs very flexible. Mode, OnSrc and OnLvl allow you to turn the LFOs on and off in different ways based on the output levels of other MPX 1 controllers. PW allows you to dynamically modify the shape of LFO waveforms. Phase lets you change the phase of the Cosine relative to the other waveforms (Sine, Triangle, and Pulse).

NOTE: In all modes, the LFO completes its current cycle before stopping. The first press of **Tap** resets the LFOs.

LFO (1 or 2)

Parameter	Range	Description
Mode	Off, On, Latch, Gate, Once, Reset, RTrig	Controls behavior of Source when OnLvl is reached
Rate	0-50.00/1:24-24:1	LFO speed
(Rate units)		Option of Rate: Hz or Cycles per Beat
PW	0-100%	Varies the pulse width of all shapes
Phase	-120° to +120°	Relative phase difference between Sine and Cosine
Depth	0-100%	Controls the amplitude of all shapes
OnLvl	0-127	Start/Stop level for Latch, Gate, Once, Reset and RTrig modes
OnSrc	Off, On, any internal or MIDI controller	Determines which control source is used to turn LFO on and off in Latch, Gate, Once, Reset and RTrig modes.

MPX 1 Internal Controllers

Knob

AeroFreeze AB [n]Ekos:Beat

LFO1 and LFO2

LFO Modes

Off: LFO is disabled (OnSrc and OnLvl are ignored)

On: LFO is always on (OnSrc and OnLvl are ignored)

In the remaining modes, when the value of OnSrc rises above or falls below the value of OnLvl the LFO is switched on and off as follows:

Latch: LFO toggles on and off whenever OnSrc value rises above OnLvl

Gate: LFO stays on while OnSrc value is greater than OnLvl

Once: LFO sweeps through one complete cycle when OnSrc value rises above OnLvl. (During the sweep, further changes of OnSrc value are ignored.)

Reset: LFO is always on, but its phase resets to 0° whenever OnSrc value rises above OnLvl.

RTrig: LFO completes one cycle when OnSrc value rises above OnLvl. (The phase of the LFO can be reset to 0° if OnSrc value rises above OnLvl during the sweep.)

Filter Thing MPX Blue

Arpeggiator

The MPX 1 arpeggiator requires a MIDI note source (keyboard, sequencer, etc.) to be connected to the MIDI IN connector. Once connected it will arpeggiate keys that are held down. You can use the arpeggiator as a source to control MPX 1 parameters (like SweepFilter fc , for example), but the real fun starts when you connect a MIDI sound source to the MPX 1 MIDI OUT connector. The arpeggiator will “play” the sound source. Parameters are provided to allow you to turn the arpeggiator on and off, connect a clock source to set the arpeggiation speed, set the order that the notes are played, and control their loudness.

Arpeggiator Modes and V Src

- Off: Arpeggiator is disabled
- Up: Notes play in ascending order
- Down: Notes play in descending order
- Up-Dn: Notes play in ascending, then descending order
- Rand: Notes play in random order
- Frwr: Notes play in the order they are held down
- Bkwr: Notes play in reverse order
- Fd-Bd: Notes play forward, then backward

The **V Src** parameter allows you to set the MIDI Velocity value for the arpeggiated notes. The range of this parameter is 0–127. When set to 0, the arpeggiated notes will have the same velocity values that were played on the MIDI source. This allows you to control the dynamics of the notes in the arpeggio by how quickly you strike the keys.

The arpeggiated notes will all have the same dynamics when **V Src** is set to values between 1 and 127 (1 is extremely soft, 127 is very loud). Try patching MIDI Mod wheel to **V Src**. Move the Mod Wheel to its minimum position and the arpeggiator will track your playing dynamics — move it beyond minimum and it becomes a volume control for the arpeggios.

Arpeggiator

Parameter	Range	Description
Mode	Off, Up, Down Up-Dn, Rand, Frwr, Bkwr Fd-Bd	Order in which notes will be played
V Src	0-127 or MIDI controller	Sets velocity value of notes played
Clock	Off, On, any internal	Arpeggio speed
OnSrc	Off, On, any internal or MIDI controller	Turns arpeggiator on or off
OnLvl	0-127	Value at which arpeggiator turns on or off

MIDI Arp 1

MIDI 16th Arp

These ADSR-type envelope generators can be gated on and off via any MPX 1 patch source. Aside from the usual attack, decay, sustain and release parameters. The MPX 1 ADRs include additional controls that allow you to further customize their behavior.

Note that the rate parameters (attack, decay and release) are logarithmic. The highest value, 100, is very fast (less than a millisecond). The lowest value, 0, is very slow (more than two minutes). Values above 50 are generally the most useful unless you are creating effects with control changes that take place over several tens of seconds.

ADR (1 or 2)

Parameter	Range	Description
Mode	Off, Once, RTrig, Loop	Cycle repetition behavior (See notes.)
OnDly	0-100	ADR output delay for multiple ADSR offset
ARate	0-100	Attack rate
DRate	0-100	Decay rate from 127 to S Lvl
S Lvl	0-127	Sustain level
STime	0-100	Length of time cycle is maintained at S Lvl while OnSrc is at or above OnLvl
RRate	0-100	Rate of change from S Lvl to 0
OnLvl	0-127	Threshold
OnSrc	Off, On, any internal or MIDI controller	Selected trigger

This controller produces a random stream of numbers whose maximum range is 0-127. You can limit both the lowest and highest values and control the rate at which the numbers are generated.

Random (Random Number Generator)

Parameter	Range	Description
RndLo	0-127	Low limit
RndHi	0-127	High Limit
Rate	0-50.00	Speed
(Rate Units)		Option of Rate: Hz or Cycles per Beat

ADR1 and ADR2

ADR Modes

- Off: ADR is disabled (OnSrc and OnLvl are ignored)
- Once: ADR completes a full attack, decay, sustain, release cycle when OnSrc value rises above OnLvl. (During the cycle, further changes of OnSrc value are ignored.)
- RTrig: ADR restarts its attack, decay, sustain, release cycle whenever OnSrc value rises above OnLvl.
- Loop: ADR repeats its attack, decay, sustain, release cycle endlessly

50's Sci Fi EkoSweepFilter

Random Generator

RandomChorus S/H Improv

A/B Glide

The A/B Glide controller is linked to the front panel **A/B** button and LEDs. Pressing the button toggles the state of the controller between A and B, as indicated by the LEDs.

When the controller is at A, its output is 0. When it is at B, its output is 127. Controls are provided to allow you to determine the rate at which it glides from A to B and from B to A.

Of the many presets in the MPX 1 that use this controller, the most straightforward example is **Rotary Cab**. In this preset, **A/B** is used to glide between the fast and slow rates of a rotary speaker effect. Different A and B rates are used to simulate the mechanical inertia of the real thing. Note that you can use the OnSrc parameter to select other controllers to initiate the glide.

A/B Glide Modes

Trig: Toggles between A and B whenever **A/B** button is pressed or OnSrc value rises above OnLvl.

Gate: Glide from A to B when OnSrc value rises above OnLvl. Glides from B to A whenever OnSrc value falls below OnLvl. The **A/B** button is ignored.

Like the LFOs, A/B Glide has several simultaneous outputs that can be used as patch sources:

A/B: The A/B Glide controller is linked to the front panel **A/B** button and LEDs. Pressing the button toggles the state of the controller between A and B, as indicated by the LEDs.

ATrg: This value changes from 0 to 127 and back to 0 again whenever A/B changes from B to A.

BTrg: This value changes from 0 to 127 and back to 0 again whenever A/B changes from A to B.

ABTrg : This value changes from 0 to 127 and back to 0 again whenever A/B changes from A to B or B to A.

A/B

Parameter	Range	Description
Mode	Trig, Gate	See notes.
ARate	0-100	Time to go from A to B
BRate	0-100	Time to go from B to A
OnLvl	0-127	Threshold
OnSrc	Off, On, any internal or MIDI controller	Selected trigger

Rotary Cab	RvbEkoMorph
Spin+Dlys	

The sample and hold controller is similar to functions found in many synthesizers. Its output is derived by “sampling” the value of an input signal. The MPX 1 version allows you to select any controller as the input signal, and also allows you to select any controller to trigger the sample.

S/H

A typical use would be to use LFO1 Sine as the input signal and LFO2 Pulse as the sampling clock. With both LFOs set to different rates, the output will be a constantly changing staircase pattern. Before you decide that this is too techno for you – be sure to listen to the presets **50’s Sci Fi** and **Synthis Izer!**

S/H (Sample & Hold)

Parameter	Range	Description
InSrc	Off, On, any internal or MIDI controller	Signal to be sampled
Clock	Off, On, any internal or MIDI controller	Selected trigger
OnSrc	Off, On, any internal or MIDI controller	Signal that gates the S/H clock
CkLvl	0-127	Threshold

50’s Sci Fi	S/H Pitch
Synthis Izer	

Env1 and Env2 are two identical envelope followers which create an output that varies with the level of the Src parameter. For each envelope follower you can choose any two audio level as sources. To follow the levels on both main inputs, set Src1 to Left Input and Src2 to Right Input. Use Resp and ATrim to customize the response to level changes. Note that these controls are logarithmic. Resp values below 50 take many seconds to “catch up” with audio level changes. For most situations, you’ll find values above 50 to be the most useful.

Env1 and Env2**Env (1 or 2)**

Parameter	Range	Description
Src (1 or 2)	Off, Left Input, Right Input, Pitch L Out, Pitch R Out, Chorus L Out, Chorus R Out, Mod L Out, Mod R Out, EQ L Out, EQ R Out, Reverb L Out, Reverb R Out, Delay L Out, Delay R Out	
Atrim	0-100	Allows attack time to be shortened relative to overall response. 0=same as Resp, larger numbers shorten response.
Resp	0-100	Responsiveness

AutoWah Chrs	Big Bottom
ChrsRvbMorph	

Footswitch Controllers The rear panel Foot Switch jack can be connected to as many as three independent analog switches. Each switch appears as two simultaneous patch sources.

Tog1: Value toggles between 0 and 127 at each off/on transition of foot switch 1.

Tog2: Value toggles between 0 and 127 at each off/on transition of foot switch 2.

Tog3: Value toggles between 0 and 127 at each off/on transition of foot switch 3.

Sw1: Value is 0 when foot switch 1 is off, 127 when foot switch 1 is on.

Sw2: Value is 0 when foot switch 2 is off, 127 when foot switch 2 is on.

Sw3: Value is 0 when foot switch 3 is off, 127 when foot switch 3 is on.

1 MPX Blue

This preset illustrates the power and complexity of the MPX 1 with 6 simultaneous effects blocks, split-path routing, and 5 patches to the internal controllers. Centrifuge and plate on one path, and a filtered, autopanned delay on the other path create a unique effect for vocals or instruments.

2 RvbEko Morph

Press **A/B** to morph between a long decay reverb and echoes.

3 480PrimeFing

The Stereo Flanger effect is used to emulate the characteristics of the Lexicon 480L Prime Flange program.

4 RandomDetune

This program uses randomly demodulated dual detuners. Press **Value** to access the overall depth of the detuning. The program loads with stereo delay and plate reverb bypassed—press **Delay** or **Reverb** to add them to the effect. Great for thickening vocals, guitars, and other instruments.

5 Vintage Trem

A new twist on a classic effect – a reverb “tank” feeding into a deep tremolo to modulate the decay of the reverb. The twist here is that, because the tremolo is stereo, the spaciousness of the reverb is maintained. Press **Value** to access controls for tremolo rate and depth as well as tweaks for the reverb.

6 Tap Delay

A single quarter-note slap. Press **Tap** twice to sync up with the beat. Press **Value** for delay rhythm, feedback and damping parameters.

7 Tape Echo

The echoes get darker as they repeat. Press **Value** for time, feedback, and damping controls.

8 ParametricEQ

A 4-band mono EQ setup like a “channel strip” equalizer – low shelf at 250 Hz, high shelf at 6kHz, and two variable mid-range bands centered at 500Hz and 3kHz. The Mod block is used to add an input volume trim for the EQ, so you can compensate for gain boost. Press **Value** for gain, frequency, and Q controls.

9 Chorus Chambr

A Chorus effect in front of a small Chamber adds dimension to any guitar or electric piano.

10 Autowah Chrs

Input level-controlled wah fed into a stereo chorus. Press **Value** for wah and chorus controls.

11 Dialog Booth

A tiny ambient space.

12 Small Booth

A small, partially dark recording booth.

13 PCM 60 Room

This program is designed to replicate a room with the smaller Size and Reverb Time settings from the Lexicon PCM 60.

14 Tiled Room

A small bright room for percussion and tight rhythm guitar.

15 Bright Room

A small, airy room. An excellent general purpose ambience effect.

16 Plate Space

A huge, bright, loooong plate reverb.

17 Ambience4 PA

Optimized for PA, this program adds "air" around vocals or other sources without making them muddy. The ambience effect is followed by a stereo 2-band EQ so you can fine tune to the room. Press **Value** to get to the critical controls fast.

18 Short Nonlin

A short bright nonlinear reverb.

19 Multigate

A short, delayed gate reverb with three syncopated repeats.

20 Gate 4 PA

Optimized for PA, this program can thicken up drums or other sources without making them muddy. The gate effect is followed by a stereo 2-band EQ so you can fine tune to the room. Press **Value** to get to the critical controls fast.

21 Plate 4 PA

A bright, dense plate tuned especially for PA use. The plate effect is followed by a stereo 2-band EQ so you can fine tune to the room. Press **Value** to get to the critical controls fast.

22 Bright Plate

A bright percussive plate with moderate decay.

23 Sweet+Wet

The name speaks for itself. This program combines tone controls, dual detuners, stereo Tap echoes and rich plate reverb. (Press and hold **Program** to see how the effects are routed.) Press **Tap** twice to change the echo rhythm. Press **Value** to get at the goodies in the Soft Row.

24 Vocal Plate

A plate reverb designed specifically with vocals in mind.

25 Snare Plate

This program has been tuned for optimal results with a Snare drum. The high setting of Rt HC without high cutoff filters allows for rapid high frequency buildup.

26 BigDrumPlate

A medium long bright plate reverb for drums and vocals.

27 DrumgateFIng

A flanged gated reverb for drums.

28 Drum Booth

A very small dead booth.

29 Big Bottom

This program adds a low frequency tone (92.5Hz) as well as a small Chamber to the audio passing through the unit. The knob allows you to tune the frequency, attack and decay characteristics of the tone.

30 Percus Place

A bright medium-sized room for percussion.

31 Snare Gate

Fatten up the snare with this short, EQ'd, gated Chamber. Controls for the gate rates and sensitivity, as well as reverb and EQ settings are in the Soft Row.

32 Md Drumroom

A medium-sized, bright room for drums.

33 Miked Room

Adds a realistic sense of space to direct sources. Chorus and delay effects are used to simulate a "close mic" sound and a parallel ambience effect provides the sound and feel of stereo far mics. A stereo volume effect, placed in the Mod block provides independent level for the far mics. Press **Value** for this parameter as well as additional ambience controls.

34 Live Room

A small bright live room with far mic's.

35 Empty Club

A small empty night club.

36 Big Studio

A big bright studio room with far mic's.

37 Garage

A medium-large highly reflective bright room.

38 Chamber&Refl

A large dark Chamber with heavy reflections and a set of short delays. This is a good program to use as a starting block for creating reverbs.

39 Chamber 101

Even a rocket scientist could figure it out. Your standard, everyday, great-sounding chamber.

40 Jazz Chamber

A medium-sized space, with a gentle EQ boost. Great for blending several direct sources into an ensemble sound.

41 Nice Chamber

A large, fairly reverberant chamber reverb.

42 Chamber Pan

A medium chamber fed into an auto panner.

43 Big Chamber

A big bright chamber reverb.

44 Chamber 4 PA

A bright, medium chamber tuned especially for PA use. The chamber effect is followed by a stereo 2-band EQ so you can fine tune to the room. Press **Value** to get to the critical controls fast.

45 Hall 4 PA

A bright, large hall tuned especially for PA use. The chamber effect is followed by a stereo 2-band EQ so you can fine tune to the room. Press **Value** to get to the critical controls fast.

46 Small Hall

The name says it all.

47 Medium Hall

A bright, empty medium-sized hall.

48 Large Hall

A very large space with a little extra emphasis in the low end.

49 Piano Hall

A long smooth hall optimized for acoustic piano. Stereo EQ follows the reverb so you can fine tune the tone or the reverberation to fit the mix.

50 Rich Hall

A large bright smooth hall.

51 Concert Hall

Big and rich – great for vocals, piano and acoustic instruments.

52 Tajma Hall

A huge reverb space with long decay.

53 Small Church

A moderately sized space with characteristics of a small chapel.

54 Cathedral

A Cathedral — for organ music.

55 M Sq. Garden

A large arena reverb. Great for imitating the big venues.

56 Morph Spaces

A/B glides from a large room to a tiny closet. Press **Value** to adjust the glide times between the two spaces.

57 Process Verb

A panned and swept filtered-hall reverb.

58 Ducker Verb

As you input a signal, the reverb level is turned down. Once the signal goes away, watch out for the wave of reverb coming your way.

59 Reverse Rvb

The reverberation density builds up very slowly, producing an eerie, backwards effect. Stereo EQ follows the Reverb block and provides some punch at 1kHz. Press **Value** to get at the critical parameters.

60 Wavewash

A fluttery, long reverb wash into a stereo chorus.

61 Ghost Flange

A stereo flanger follows a reverse reverb effect, with ghostly results. (Can you say poltergeist?). Great for vocal sound effects, but be sure to try it with a sustaining guitar solo.

62 Phased Space

A strange ambience reverb with slight slap delay and phasing.

63 Mod Space

A tremolo'd and slightly delayed short ambience reverb.

64 DoubleEQ Rvb

A bright, EQ'd and slightly predelayed small room reverb.

65 Rev Wahtouch

A bright reverse reverb through a wah. The wah filter is controlled by input level.

66 Tap GatedRvb

A tempo-controlled LFO is used as a rhythmic gate to a large plate. The gate is opened every other beat for the duration of an eighth-note. Use this program to add reverb to selected beats of a stereo source. Press **Tap** twice to sync up with the beat.

67 TapDly/Rvb

Use this program as a simple **Tap**-driven delay with moderate feedback, or press **A/B** to add a clean plate on a separate path. Great for live sound where you can **Tap** in the delay and then bring reverb in and out with **A/B**.

68 Diffuse DlYS

This program uses the delay Fbk Insert Option to place an ambience effect inside of the delay feedback loop. The result is echoes that grow more diffuse as they repeat. A subtle alternative to plain vanilla delays, this program will thicken up acoustic sources without detracting from them.

69 IPS Tape Slap

Press **A/B** to select delays that simulate 7 1/2 or 15 ips tape slaps.

70 Frame Delay

A stereo delay that allows audio to be offset by as many as 5 frames at 30 frames per second. Press **Value** to find the Frames control in the Soft Row.

71 DlyFlangePan

A cool multi-effect combo. Mono echo, stereo flanger, auto panner and plate reverb. Press and hold **Program** to check out the routing of these effects. Press **A/B** to glide between fast and slow pan rates. Use **Tap** to change delay times. Press **Value** for the key controls for each individual effect.

72 ChaseEkoPan

Auto panner and echo effects combined so that the echoes chase the dry signal through stereo space. **A/B** glides between slow and fast pan rates. Press **Tap** twice to set the echo rhythm.

73 Delay>Detune

A detune block that is fed into a regenerating delay creates a big impression on small sounds.

74 Ducked Delay

A delay effect that is controlled by input level. The delays are ducked out of the way when the input is moderate to loud, but rise in level when input gets very soft or stops. A nice way to put some repeats on the end of phrases.

75 Spin + DlYS

This multi-effect combination is a great alternative to chorus/delay or rotary/delay programs. Detuned echoes are sent through an auto panner and plate reverb. Press **A/B** to glide between fast and slow pan rates. Press **Tap** to change the echo rhythms.

76 Ping Pong

Echoes that bounce back and forth between left and right sides of a stereo mix.

77 Swept Echoes

On the upper path is an autopanned, envelop-driven wah. The lower path is a tap-controlled dual delay. This is a great dynamic effect for vocals or instruments.

78 EkoSweepFltr

This program employs the 4-pole resonant sweep filter. Its frequency is swept by the output level of the dual delay that feeds into it – and it's inside the delay feedback loop! Way cool with percussive sources. Be sure to check this one out with guitar and bass too.

79 Rockabilly

Single slap tape echo combined with some tasty ambience.

80 Guitar Solo

Detune, echo and reverb, combined for melodic guitar solos.

81 Sax Solo

Detune, echo, reverb and EQ combined to sweeten melodic woodwind solos.

82 Sidestik/Snr

A Hall reverb in conjunction with a mono band pass filter tailored specifically for drum sounds.

83 MIDI Dot 8th

Great delay factor for lead vocals. Set your MIDI controller to send tempo information to the MPX-1.

84 MIDI 1/4Note

MIDI tempo in, 1/4 note out.

85 AeroFreezeAB

Press **A/B** to freeze the sweep of this slow resonant flanger effect. You'll find a "Manual" control in the Soft Row to let you manually adjust the sweep point. This program really shines with sustaining, broad band sources – distorted guitars, drums, sound effects – even an entire mix. You'll find all sorts of spatial and comb effects just dialing in different values.

86 Wide Chorus

A silky smooth chorus that adds width to anything sent through it. Press **A/B** to add speed and wobble to the chorus. Excellent for guitars and keyboards.

87 RandomChorus

The multi-voice stereo chorus effect in this program has rate and depths randomized by the Random generator and S/H.

88 Chorus Hall

A stereo chorus fed into a medium large hall.

89 ChrsRvbMorph

Input level controls morphing between stereo chorus and plate reverb. Loud signals are chorus only. As the signal fades, the program morphs from the chorus to the reverb. Useful with any dynamic source.

90 Another Brick

This echo/chorus program was inspired by Pink Floyd. "Hey! Leave those kids alone!"

91 Rich ChrsEko

Dual echoes combined with rich chorus. The chorus is inserted in the echo feedback loop so every delay is recirculated through the chorus.

92 Dynamic Chrs

Input level controls the depth of this stereo chorus effect. The effect is very slight for loud signals, but increases dramatically as the level fades. (A hint of stereo echo is added as well.) Good with any dynamic source, but a killer with electric and acoustic guitars.

93 Rubberate

A comb flange controlled by input level with slight delays and ambience.

94 FlangeNonlin

A flange fed into a nonlinear reverb.

95 TalkinFlange

A throaty vowel effect controlled by input level. Works well with percussive or melodic sources.

96 Tape Flange

Simulated version of over-the-top analog tape flanging.

97 CircleFlange

A resonant multiswept high flange in a small reverberant space.

98 Slow Flange

A slow sine wave attached to the flanger's depth creates a patiently flanged effect.

99 FlangSweepAB

A very deep, fixed resonant flange with added delays. Press **A/B** to initiate a single sweep. Press **Value** to change sweep rates, resonance and delay times.

100 EP Tremolo

A Rhodes-like satellite tremolo with some detuning and reverb.

101 Phat Detune

This detune and delay effect will really thicken up sustained sounds. Try it with synthesizer pads, sustained guitar chords, or any long tones.

102 Detune&Dlys

Dual detuner combined with dual delays. The detuner is inserted in the delay feedback loop so delays are detuned further with each repeat. A very useful, general purpose delay effect.

103 Detune+Hall

For the creamiest detuning, this preset's the one — with an LFO constantly inverting the two detunes. Press **A/B** to add a medium hall on another path.

104 Pitch-O-Latr

Fast stepped and panned pitch shifters with a slight hall reverb.

105 S/H Pitch

Definitely a special effect! The pitch shifter is controlled by the S/H generator to create semi-random angular melodies, which are internally routed through a delay and reverb. As the pitch shift effect is driven by input level, things don't start to get weird until the level is pretty low.

106 Uni to Chord

Press **A/B** to glide from unison to major chord.

107 Doubler

Detuners and delays combined to produce randomized double track effects

108 Wet Triads

Need some extra harmony? Load this and you've instantly got major chords. Need some minors instead? Press **A/B** to change the chord status. By the way, you're playing the third of the chord...

109 Up 3 Down 5

Standard triad harmony. Press **A/B** to change the third from major to minor.

110 4 Funky Comp

A detuned and phased signal fed into a very very small predelayed hall reverb.

111 5th Plate

A pitch shifter tuned to a fifth, fed into a medium plate.

112 5th Octaverb

A larger hall reverb fed into pitch shifters set to fifth down and octave up.

113 Oct Cascade

Octave pitch shifts recirculated through delays. **A/B** selects between octave below or above the original pitch.

114 Power Chords

A 2-voice pitch shifter with one voice set for octave down. **A/B** toggles the second voice between down a fourth and unison detune.

115 EkoVerbSweep

Flanged ping pong delays in a medium hall.

116 Telephone

A basic telephone filter with some added distortion.

117 TV in Room

A slightly distorted mono TV set in a carpeted living room. Press **A/B** to cut the TV filter in and out.

118 Car Radio

The EQ is tuned to simulate a car radio. Ambience is set up to simulate an automobile interior. Overdrive adds some distortion. Press **A/B** to switch between AM and FM.

119 Capture EQ

This program is designed to help you find the perfect EQ settings without having to constantly rewind tape, or having to ask the drummer to keep whacking the tom until you find what you need. A loop delay feeds a mono parametric EQ. Roll the tape (whack the tom) and press **A/B** to capture a 2-second sample that will repeat endlessly while you dial in the perfect EQ. (Press **Value** for the EQ controls.) When you're ready, press **A/B** again to kill the loop.

120 Miked Cab EQ

Need to add some realism to a direct recorded distorted guitar track? EQ and ambience are used together to simulate a guitar cabinet miked in a small live room. Press **A/B** to switch between closed and open back cabinets.

121 Vocal EQ

3-band parametric EQ optimized for vocal tracks. A Mod block volume effect is used as an input trim to the EQ. This program loads with the reverb block bypassed. Press **Reverb** to add a rich plate reverb after the EQ.

122 GuitarCab EQ

A great finishing touch for direct guitar or keyboard tracks. The EQ in this program has been tweaked to simulate a guitar cabinet. Press **A/B** to switch between closed and open back versions.

123 Tone 4 Gtr

Mono 4-band EQ set up like Low, Mid, Presence and High tone controls.

124 Phased Place

A small room with predelay and phase shifting.

125 Fazer->DlyPan

Phase shifter, tap tempo echo and panners are combined to produce a richly undulating wash of tone. Dry and delayed versions of the phase shifter are panned separately and chase each other through stereo space. Press **Tap** to change the echo rhythm. Press **A/B** to glide between fast and slow pan rates.

126 FazerEkoRvb

A cool combination of classic effects. The phase shifter is inserted inside of the echo feedback loop so that each repeat is recirculated through the phase shifter.

127 FazerTremolo

Here's a program that really shows off the power of the routing system. The first effect is a crossover EQ. Low frequencies (below 800Hz) are routed through a phase shifter, and from there into an ambience effect. The high frequencies (above 800Hz) are routed separately to a stereo tremolo.

128 PhaserOnStun

The name says it all.

129 DbIPhaseGate

A small short gate-type reverb with slap delay and phase shift.

130 WahFazerPdl

Plug in a foot pedal and this one's ready to go. A phase shifter feeds a pedal wah which has some reverb added to it.

131 Wah Delays

A sweeping wah filter fed into repeating ping pong echoes.

132 Wah Pan Dly

A wah wah filter fed into repeating panning delays.

133 Wah Ped+Dist

Here's your classic wah pedal. Need that extra boost to get it up to 11? Press **A/B** to add some overdrive before the wah.

134 Echo-Wah

A fluttery wah-swept sound with ping pong echoes.

135 Res A/Bsweep

Press **A/B** to trigger a single sweep of a resonant filter which, in turn, feeds into rhythmic echo and chamber effects.

136 Filter Thing

Panning and double-swept resonant lowpass filters fed into a small hall reverb.

137 BigGtrChords

This program enhances just about any guitar sound, but it's a stand out with big open, ringing chords.

138 Rock Organ

An alternate rotary speaker effect – dark and gritty. If you listen carefully, you can even hear the wind noise created by the horn wizzing past the mike. Press **A/B** to switch between fast and slow speeds. This program is already set up to use MIDI AfterTouch to toggle between slow and fast speeds.

139 OD Rotary

A rotary speaker effect with some built-in overdrive. Press **A/B** to switch between fast and slow speeds. This program is already set up to use MIDI AfterTouch to toggle between slow and fast speeds.

140 Rotary Cab

This program emulates a Leslie speaker and adds a bit of Chamber to fatten up the sound. MIDI Controller 68 (Legato) is pre-patched to A/B for remote fast/slow of the rotating speakers.

141 SynthChamber

SweepFilter in front of Stereo Flanger and Chamber to add a resonant, shimmering effect with a hint of space to any dynamic instrument.

142 Touch Spinner

A detuned phased signal fed into a hall reverb. The motion speeds up as you play louder.

143 Random Pan

This program moves a signal randomly between left and right sides of the stereo mix.

144 StereoSpin

A rotary speaker alternative – great for guitar and keyboard, or as an alternative vocal effect. The input is detuned, then sent through a crossover. The low and high frequency outputs are then routed separately into an auto panner. From there, stereo delay and ambience are added. Press **A/B** to glide between slow and fast pan rates.

Programs 145-152 are designed for dual mono applications. The left and right channels each have independent mono effects. We had PA applications in mind when we created these, but you'll find they come in handy whenever you want to get the most out of your console's aux sends.

145 L=Dly R=Chmb

Left channel echo. Right channel large room reverberation.

146 L=Dly R=Ambi

Left channel echo. Right channel ambience.

147 L=Dly R=Dtun

Left channel echo. Right channel detuner.

148 L=Ptch R=Chmb

Left channel pitch shifter. Right channel large room reverberation.

149 L=Dly R=Ptch

Left channel echo. Right channel pitch shifter.

150 L=2BndR=Chmb

Left channel 2-band EQ. Right channel large room reverberation.

151 Dual 2-Band

Independent 2-band EQ's on the left and right channels – each with independent gain, frequency and Q for both bands.

152 Dual TapDlys

Independent tap delay on the left and right channels. Each with its own delay rhythm, feedback and damping controls.

153 Ghost Mist

A phased ping pong delay into a long strange ambience reverb. Kind of creepy!

154 Submarine

Who could have possibly fathomed an underwater sound as deep as this?

155 50's Sci Fi

Inspired by the score of "Forbidden Planet". This preset plays a cascade of descending pitches all by itself — complete with echoes and reverberation! Press **A/B** to turn off the pitch generator and process the input of your choice.

156 Synthis izer

A randomly swept filter with mono flange and reverse reverb. Great with sustained sounds.

157 S/H Improv

In this program, every input note is shifted chromatically to a different note within a one-and-a-half octave range. The shift is triggered by input level — a new note for each attack. The rhythm of your playing determines the overall "shape" of the melodies produced. Check it out with any percussive source. It works particularly well with muted guitar or bass.

158 MIDI Arp 1

This program is designed to work with a MIDI keyboard or sequencer. Connect the keyboard MIDI OUT to the MPX 1 MIDI IN and MPX 1 MIDI OUT to the MIDI IN of any MIDI sound source. When you play two or more notes at once on the keyboard, the MPX 1 will automatically arpeggiate them. Press **Tap** twice to set the arpeggiator speed. Run the audio of the MIDI source into the MPX 1 and you'll hear phase shifting and delay synchronized to the arpeggiator. Audio is panned with the arpeggiator as well — lower notes to the left and higher notes to the right.

159 MIDI 16thArp

Similar to **MIDI Arp 1**, but with a 16th note rhythm and different effects.

160 A/B Freeze

Press **A/B** to freeze the last two seconds of audio into an endless loop. The loop is played through an Aerosol flanger. Press **A/B** again to kill the loop.

161 VolumePedal

This program is designed to work with a volume pedal connected to the MPX 1 pedal input. The input is routed through a pedal-controlled volume effect in the Mod block. From there, it travels through a crossover, dual detuners, stereo delay and ambience — all in series. Pump the pedal to create ethereal crescendos of sound. If you don't have a pedal connected, and you want to listen to the effects in this program, press **Mod** to bypass the volume effect.

162 Open the Door

This program was made for dialog and sound effect work. It puts your sound inside a small ambient room. Press **A/B** to open and close the door.

163 No Traction

Have you ever felt stuck in life. A large hall with panned pitch shifting that rises and speeds up with strength of input signal.

164 Call Waiting

Need to simulate "call waiting" for dialog sound effect? This will do it. The basic effect is a telephone filter, but you can press **A/B** to interrupt the dialog and inject a call-waiting beep.

Programs 165-199 each contain a single effect. While each of these programs is meant to be used alone, many can be used as building blocks when you create your own multi-effect programs from scratch. Use Copy Effect in Edit mode to copy different combinations of these effects into a single program.

165 ClassicDtune

A simple, but very useful effect. Use it to fatten up just about anything in a PA or recording mix. The left side is shifted up 8 cents, and the right side is shifted down 8 cents.

166 Major/Minor

The first parameter in the Soft Row selects A Major or minor 3rd above for the left output. The right output is a perfect fifth above.

167 Transposer

The first parameter in the Soft Row lets you change the key of your processed sound.

168 Stereo Shift

The first parameter in the Soft Row allows you to shift the pitch of a stereo signal in semitones.

169 MIDIfixVocal

Use MIDI Pitch Bend to pitch shift your stereo signal, in 1 cent intervals, ± 1 semitone.

170 Tuning Note

An internal sine wave generator is set to output a tone equivalent to A4. The first parameter in the Soft Row changes the pitch.

171 Rich Chorus

The name says it all.

172 Rotary

Fast speed rotary cabinet.

173 Aerosol

Deep resonant stereo flanger.

174 Phaser

Slow speed phase shifter.

175 Flanger

Slow mono flanger with lots of resonance.

176 Comb

Comb filter set to create a highly colored sound. Change the value of the Comb parameter to change colors.

177 Stereo 2Band

2- band stereo parameteric EQ.

178 DigitalEQ(S)

Stereo 2-band EQ routed for best digital performance.

179 DigitalEQ(M)

Mono 4-band EQ routed for best digital performance.

180 Crossover

In this crossover EQ effect, the input is summed to mono. Frequencies below the crossover point are sent out the left output and frequencies above the crossover point are sent out the right output.

181 Wah Pedal

The wah effect, patched up for pedal control.

182 Pedal Filter

Four pole resonant filter with pedal-controlled cut-off frequency. A very analog sounding effect.

183 3-Tone

A simple low, mid, high tone control.

184 LFO Filter

A low pass filter modulated by an LFO.

185 RumbleFilter

EQ with very steep roll-off below 50 Hz created by cascading four low shelf filters. Frequency control is in the Soft Row. For best results, set all four to the same frequency.

186 DynaTremolo

This preset follows your playing note for note and behaves accordingly. The harder you play, the faster the tremolo. As your notes die out, the tremolo slows down. Perfect for electric guitar and organ.

187 Auto Pan BPM

An auto panner set to pan once per quarter-note. Press **Tap** twice to sync up with the beat.

188 Broken Speakr

Overdrive effect is used to simulate the sound of a broken speaker.

189 Short Delay

A 125 millisecond slap.

190 Double Delay

A repeating double eighth-note pattern. Press **Tap** twice to sync up with the beat.

191 [n]Ekos Beat

A basic tempo-controlled echo effect. Press **Tap** twice to set the tempo of a beat. Press **Value** to access the [n] control – which determines the number of echoes per beat.

192 ShuffleDly

Delays that repeat in a shuffle pattern.

193 Dual Echoes

Independent echoes on the left and right channels.

194 Wild Thing

A syncopated repeating delay.

195 Small Foley

A small Ambience effect adds light space to any sound effect recording.

196 Small Room

A small bright rectangular room.

197 Drum Gate

A bright gated reverb for drums.

198 Small Gym

Come back with me to those good old high school days. This preset is great for recreating those squeaky sounds your sneakers use to make on those wooden floors.

199 Tight Plate

A nice short plate reverb for drums and percussion.

200 Clean Slate

Want to start from scratch? This one's as empty as they get.

Troubleshooting

This chapter is intended primarily to help you recognize some common error states which can be corrected from the MPX 1 front panel, or by simple means such as cable replacement. Any error states which are not covered here should be referred to your local dealer or Lexicon Customer Service.

In a low-voltage, or "brown-out" condition (less than 40VAC), the MPX 1 will freeze in its current state. None of the controls will have any effect. When power returns to a normal level, the unit will reset itself as though it had just been powered on. If the unit does not reset itself, turn the power OFF, then ON to resume normal operation.

Low Voltage

Temperature extremes may cause the MPX 1 to exhibit unpredictable behavior. If the unit has been subjected to temperatures below 32°F (0°C) or above 95°F (35°C), it should be turned off and allowed to return to normal temperature before use. The unit may be damaged by exposure to temperatures below -22°F (-30°C) or above 167°F (75°C), or by exposure to humidity in excess of 95%. If a unit exposed to such conditions fails to operate after it returns to a normal operating temperature, contact your local service representative.

Overheating

The MPX 1 doesn't respond to MIDI Program Changes.

The MPX 1 and connected devices must be set to matching MIDI Channels, or the MPX 1 must have OMNI selected for receipt of MIDI messages. In the **System** mode **MIDI** menu, check the **Receive** control for the MIDI Channel selected, as well as the MIDI Channel of the transmitting device.

Common MIDI Problems

Make sure that **Pgm Change** in the System mode **MIDI** menu is set to **On**. See Chapter 6: *MIDI Operation* for Program Change messages which may be ignored by the MPX 1.

Check MIDI In/Out connections between the units.

MIDI Program Change numbers are off by 1.

The MPX 1 transmits and recognizes ProgramChange messages 0-127. MIDI devices which transmit 1-128 rather than 0-127, will be off by 1.

The MPX 1 doesn't respond to SysEx commands.

Check the **SysEx** setting (and the **Receive Device ID** selection) in the **System** mode **MIDI** menu.

The MPX 1 does not transmit SysEx Automation commands.
Check the **Automation** setting (and the **Xmit Device ID** selection) in the **System** mode **MIDI** menu.

Operational Problems **The MPX 1 will not lock onto an incoming digital signal.**
Check the cables that you are using. **DO NOT USE ANALOG AUDIO CABLE TO CONNECT DIGITAL AUDIO.**

Check to make sure that your input signal complies with S/PDIF format standards. The MPX 1 will only lock onto valid 44.1kHz signals.

The front panel knob and the < and > buttons are not performing the expected function.

In **Edit** and **System** modes, the **Value** button acts as a toggle to determine whether the knob or the < and > buttons perform the functions of selecting displayed items, or adjusting their values.

No Effects Output

Check the setting of Mix Mode in the System mode Setup menu, the setting of Mstr Mix and Lvl at the Mix button and the Effect Mute at the Bypass button. Also verify that any controllers patched to **Input Level**, or **Mix** are not turned off.

Power On Behavior The MPX 1 performs a series of self tests each time it is powered on, then displays the MPX 1 copyright notice. This should be followed by the display and loading of the last loaded effect. If this sequence does not occur, contact Lexicon Customer Service.

MPX 1 Specifications

Audio Input	Connectors:	1/4 inch T/R/S phone jacks (2), XLR 3-wire balanced (2)
	Impedance:	+4dB/BAL switch position: 100k Ω -10dB/UNBAL switch position: 50k Ω
	Levels:	+4dB/BAL switch position: -2dBu min for full scale, +20dBu max -10dB/UNBAL switch position: -14dBu min for full scale, +8dBu max
	CMRR:	+4dB/BAL switch position: 40dB minimum, 10Hz to 20kHz
Audio Output	Connectors:	1/4 inch T/R/S phone jacks (2); XLR 3-wire balanced (2)
	Impedance:	600 Ω , unbalanced
	Levels:	+18 dBu max, full scale
A/D Performance	Frequency Response:	20Hz to 20kHz, ± 1 dB
	Crosstalk:	-60dB max
	S/N Ratio:	90dB min, 20kHz bandwidth
	THD:	0.01% max, 20Hz to 20kHz
	Dynamic Range:	90dB min, 20kHz bandwidth
	Delay:	55.5 samples (1.25ms @ 44.1kHz)
	Frequency Response:	20Hz to 20kHz, ± 1 dB
D/A Performance	Crosstalk:	-60dB max
	S/N Ratio:	95dB min, 20kHz bandwidth
	THD:	0.01% max, 20Hz to 20kHz
	Dynamic Range:	95dB min, 20kHz bandwidth
	Delay:	25 samples (0.57ms @ 44.1 kHz)
	Frequency Response:	20Hz to 20kHz, ± 1 dB
	Crosstalk:	-60dB max
A/A Performance	S/N Ratio:	95dB typical, A-weighted
	THD:	0.01% max, 20Hz to 20kHz
	Dynamic Range:	95dB typical, A-weighted
	Connectors:	Coaxial, RCA type
	Format:	conforms to S/PDIF CP-340 Type II
Digital Audio Interface	Sample Rate:	44.1kHz

Internal Audio Data Paths	Conversion:	18 bit A/D, 20-bit D/A
	DSP:	32 bits
	S/PDIF I/O:	24 bits
Control Interface	MIDI:	7-pin DIN connector for MIDI IN/powerd bidirectional remote 5-pin DIN connectors for MIDI THRU and OUT
	Footswitch:	1/4 inch T/R/S phone jack for 3 independent footswitches
	Foot pedal:	1/4 inch T/R/S phone jack (10k Ω min, 100k Ω max impedance)
	Remote	
	Power In:	2.5mm barrel for 9VAC remote power
General	Dimensions:	19.0"W x 1.75"H x 9.0"D (483 x 45 x 289mm) 19 inch rack mount standard, 1U high
	Weight:	Net: 6lbs 2oz (2.8kg) Shipping: 9lbs 3oz (4.2kg)
	Power	
	Requirements:	100-240VAC, 50-60Hz, 25W, 3-pin IEC power connector
	Environment:	Operating temperature: 32° to 104°F (0° to 40°C) Storage temperature: -22° to 160°F (-30° to 70°C) Humidity: maximum 95% without condensation
Electrical Approvals	Safety	
	Compliance:	UL1419 and CSA 22.2 No. 1-94 (UL and C-UL marks) EN60065 (TUV-GS and CE marking per Directive 73/23/EEC)
	EMC	
	Compliance:	FCC Class B EN55022 Class B and EN50082-1 (CE marking per Directive 89/336/EEC)

Specifications subject to change without notice.